

# TOUTE LA SIGNALÉTIQUE INDOOR & OUTDOOR

Simplifiez-vous la vie !



BEACHFLAG • PAVILLONNERIE • IMPRESSION GRAND  
FORMAT • TENTE PLIANTE • TENTE GONFLABLE • ARCHE  
PVC • MUR D'IMAGE • AFFICHAGE FIXE • PLV • AFFICHAGE  
MOBILE • STAND • MOBILIER • AMÉNAGEMENT D'ESPACE



# Matériel signalétique extérieure



## BEACHFLAG ORIFLAMMES

PACK RESIST'O.....	4
PACK STABIL'O.....	6
PACK PRIM'O.....	7
BEACHFLAG À LA CARTE.....	8
ACCESSOIRES.....	9



## TENTES PLIANTES

PACK SUBLIM'O.....	12
PACK NOMAD'O.....	14
PACK PRIM'O.....	16
PACK INDUST'O.....	17
TENTES À LA CARTE.....	19



## MATÉRIEL GONFLABLE

TENTE XROOF.....	22
ARCHE STABIL'O.....	24
TOTEM.....	26
BOUÉE.....	27



## PAVILLONNERIE

STREET KAKEMONO.....	30
PAVILLON SUR MESURE.....	31
SUPPORTER.....	31
GRAND TIFO.....	31

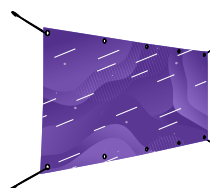

## IMPRESSION GRAND FORMAT

BANDEROLE & BÂCHES.....	34
IMPRESSION TISSU.....	35
PANNEAUX ET ENSEIGNES.....	36
ADHÉSIFS & PAPIER.....	37

# Signalétique et Display



## MUR D'IMAGE

MUR POP-UP.....	40
MUR TUBULAIRE.....	41
PHOTOCALL.....	42
CADRE LUMINEUX.....	43
CADRE ALUMINIUM.....	44
ENSEIGNE ALUMINIUM.....	45

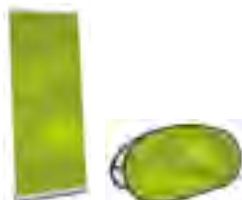

## AFFICHAGE MOBILE

X BANNER.....	56
ROLL UP.....	57
WALKING BANNER.....	58
TOTEMS POP-UP.....	59
BARRIÈRES POP-UP.....	60
BARRIÈRES SUR CADRE.....	61



## AFFICHAGE FIXE & PLV

TABLE FLAG.....	48
DRAPEAUX.....	49
SUSPENSIONS POP-UP.....	50
SUSPENSIONS TUBULAIRES.....	51
SKY DANCER.....	52
STOP TROTTOIR.....	53



## MOBILIER & AMÉNAGEMENT

TABLE & MANGE DEBOUT.....	64
COMPTOIR POP-UP.....	65
FLEX CUBE.....	66
PARASOL & TRANSAT.....	67



**LEXUS**  
EXPERIENCE AMAZING

**FULL HYBRID**  
LEXUS  
EXPERIENCE AMAZING

**LEXUS**  
EXPERIENCE AMAZING

X 300h

NX 300h

LEXUS  
EXPERIENCE AMAZING





## Beachflag

- + Pack Resist'o
- + Pack Stabil'o
- + Pack Prim'o
- + À la carte
- + Accessoires





**PACK TOUT COMPRIS**  
FIBRE EPOXY/CARBONE

- + Flexible
- + Résistant
- + Léger
- + Garantie à vie



Sac de transport



Ultra léger



Sans outils

**INCASSABLE**



**Mât en fibre Epoxy avec 15% carbone**  
Mémoire de forme et légèreté

**INTORDABLE**



**Roulement double cage 37 mm + axe renforcé 20mm**  
Impossible à tordre et pivote avec le vent

**ERGONOMIQUE**

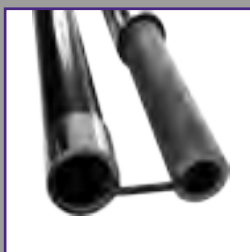

**Segments reliés et rangés dans son sac**  
Impossible de perdre les éléments

**ESTHÉTIQUE**

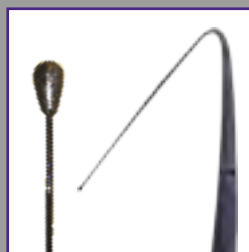

**Forme conique et tête ajustée**  
Flex parfait sans tension ni déformation

**IMPRESSION**



**Maille drapeau 115g avec fourreau épais**  
Impression par sublimation

COMPARAISON  
MÂT ALU / MÂT EPOXY

après 1 jour exposé à 30 nœuds de vent

PACK RESIST'O

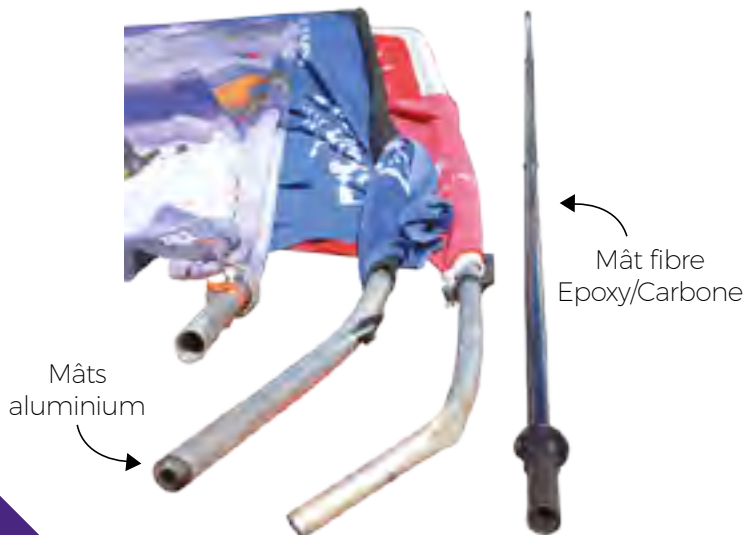

Drapeaux en situation extrême lors du record du monde de vitesse de kitesurf avec un vent de 65 noeuds



## PACK RESIST'O S



Mât 250cm  
Voile 65x200cm



Platine 5kg



Sac de transport



## PACK RESIST'O L



Mât 350cm  
Voile 70x280cm



Platine 10kg



Sac de transport



## PACK RESIST'O XL



Mât 450cm  
Voile 80x400cm



Platine 15kg



Sac de transport



## PACK STABIL'O

La solution pour les zones de « grand vent »



### PACK TOUT COMPRIS LES AVANTAGES

- + Ne tombe pas = durée de vie prolongée de 50%
- + Stable face à toute épreuve
- + Reste en extérieur toute l'année = pas de manipulation physique quotidienne



Sac de transport



Ultra léger



Sans outils



Mât fibre de verre Epoxy + 15% carbone relié par élastique



Croix 14kg avec large empatement de 85cm pour la stabilité



Roulement double cage 37mm et axe renforcé 20mm



Sac compartimenté pour un rangement et un transport pratique



Maille micro-perforée 115g avec impression par sublimation

### PACK STABIL'O S



- + Mât 250cm
- + Voile 65x200cm
- + Croix extérieure 14kg
- + Sac de transport

### PACK STABIL'O L



- + Mât 350cm
- + Voile 70x280cm
- + Croix extérieure 14kg
- + Plot béton 10kg
- + Sac de transport







LES AVANTAGES

- + Rapport qualité / prix
- + Fourreau imprimé
- + Pack tout compris
- + Impression par sublimation

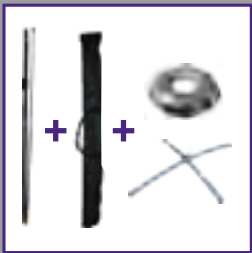

Kit tout compris  
mât + voile + croix 1.5kg  
avec lest à eau de 10L



Sommet renforcé pour  
protéger et enfiler  
la voile facilement



Mât avec segments  
emboîtables pour une  
utilisation pratique



Structure en fibre de  
verre pour allier  
souplesse et résistance



Fourreau imprimé  
façonné dans la maille  
drapeau 115g

PACK PRIM'O S



- + Mât 240cm
- + Voile 65x200cm
- + Pied en croix 1.5kg
- + Lest à remplir 10L
- + Sac de transport

PACK PRIM'O L



- + Mât 350cm
- + Voile 70x280cm
- + Pied à remplir 25kg
- + Sac de Transport

MONTAGE EN 30 SECONDES

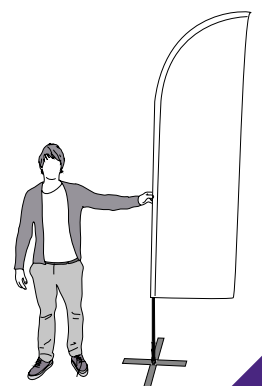
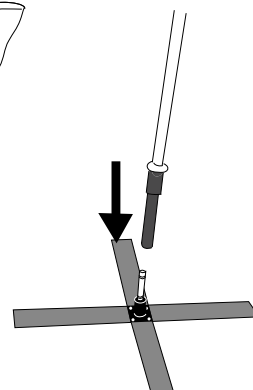
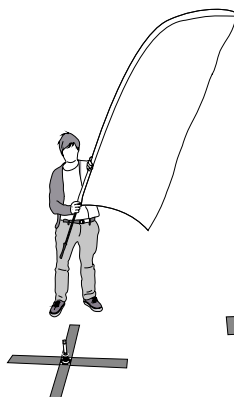
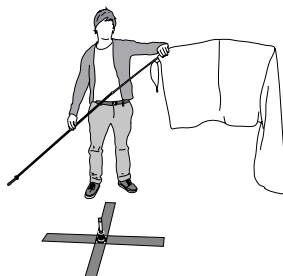
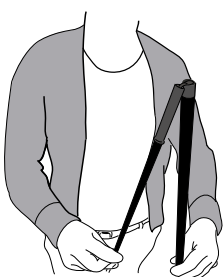

PACK PRIM'O

	FINITIONS				PIEDS NOMADES				PIEDS LOURDS					SPÉCIFIQUES			
	Recto/verso	Fourreau imprimé	Fourreau épais noir	Fourreau noir	Croix eco 1,5kg	Croix légère 3kg	Croix extérieure 4kg	Plot béton 10kg	Pied parasol 15L	Pied parasol 25L	Platine 5kg	Platine 10kg	Platine 15kg	Croix extérieure 14kg	Vrille sol meuble	Piquet à frapper	Pied autocal
<b>Forme Sea</b> Dimensions en cm																	
XS (mât 225 - voile 50x175)	-	✓	-	✓	✓	✓	✓	-	-	-	✓	-	-	-	✓	✓	✓
S (mât 250 - voile 65x200)	✓	✓	✓	✓	✓	✓	✓	✓	-	-	✓	-	-	-	✓	✓	✓
L (mât 350 - voile 70x280)	✓	✓	✓	✓	-	✓	✓	✓	✓	✓	-	✓	✓	✓	✓	✓	✓
XL (mât 450 - voile 80x400)	-	✓	✓	✓	-	-	✓	-	✓	✓	-	✓	✓	✓	✓	✓	✓
Giant 5m (voile 400x100)	-	-	-	✓	-	-	✓	-	-	✓	-	-	-	✓	-	-	-
Giant 6m (voile 500x100)	-	-	-	✓	-	-	✓	-	-	✓	-	-	-	✓	-	-	-
Giant 7m (voile 600x100)	-	-	-	✓	-	-	✓	-	-	✓	-	-	-	✓	-	-	-

	FINITIONS				PIEDS NOMADES				PIEDS LOURDS					SPÉCIFIQUES			
	Recto/verso	Fourreau imprimé	Fourreau épais noir	Fourreau noir	Croix eco 1,5kg	Croix légère 3kg	Croix extérieure 4kg	Plot béton 10kg	Pied parasol 15L	Pied parasol 25L	Platine 5kg	Platine 10kg	Platine 15kg	Croix extérieure 14kg	Vrille sol meuble	Piquet à frapper	Pied autocal
<b>Forme Plume</b> Dimensions en cm																	
S (mât 220 - voile 80x195)	✓	✓	✓	✓	✓	✓	✓	✓	-	-	✓	-	-	-	✓	✓	✓
L (mât 350 - voile 100x300)	✓	✓	✓	✓	✓	✓	✓	✓	✓	✓	-	✓	✓	✓	✓	✓	✓
XL (mât 480 - voile 120x350)	-	✓	✓	✓	-	-	-	-	✓	✓	-	✓	✓	✓	✓	✓	✓

	FINITIONS				PIEDS NOMADES				PIEDS LOURDS					SPÉCIFIQUES			
	Recto/verso	Fourreau imprimé	Fourreau épais noir	Fourreau noir	Croix eco 1,5kg	Croix légère 3kg	Croix extérieure 4kg	Plot béton 10kg	Pied parasol 15L	Pied parasol 25L	Platine 5kg	Platine 10kg	Platine 15kg	Croix extérieure 14kg	Vrille sol meuble	Piquet à frapper	Pied autocal
<b>Forme Hit</b> Dimensions en cm																	
S (mât 210 - voile 75x150)	✓	✓	✓	✓	✓	✓	✓	✓	-	-	✓	-	-	-	✓	✓	✓
L	✓	✓	✓	✓	✓	✓	✓	✓	✓	✓	-	✓	✓	✓	✓	✓	✓
XL (mât 420 - voile 75x380)	-	✓	✓	✓	-	-	-	-	✓	✓	-	✓	✓	✓	✓	✓	✓
Giant 5m (voile 400x100)	-	-	-	✓	-	-	✓	-	-	✓	-	-	-	✓	-	-	-
Giant 6m (voile 500x100)	-	-	-	✓	-	-	✓	-	-	✓	-	-	-	✓	-	-	-

## MONTAGE EN 30 SECONDES

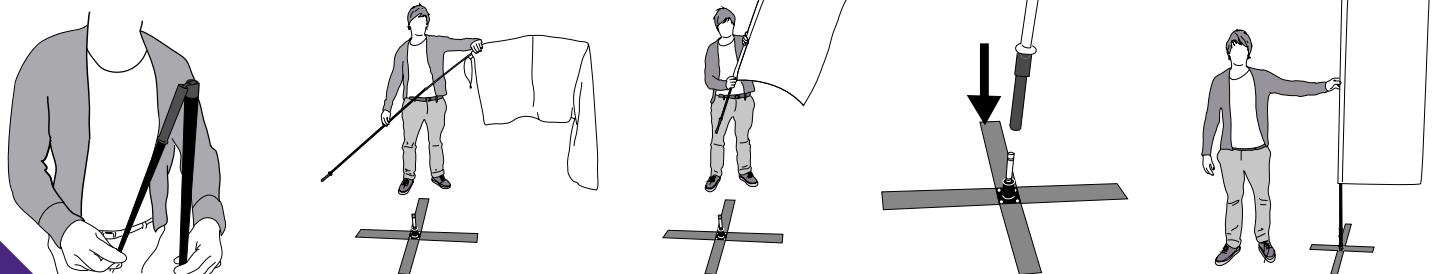

PIEDS NOMADES



**Croix eco intérieure**

78 x 60 cm - 1.5 kg



**Croix légère chromée**

100 x 100 cm - 3 kg



**Croix extérieure**

80 x 80 cm - 4 kg



**Plot béton**

ø 40 cm - 10 kg

PIEDS LOURDS



**Pied parasol à remplir**

45 x 45 cm - 15 L  
60 x 60 cm - 25 L (avec roulettes)



**Platine**

40 x 40 cm - 5 kg  
40 x 40 cm - 10 kg  
50 x 50 cm - 15 kg



**Croix extérieure**

85 x 71 cm - 14 kg

PIEDS SPÉCIFIQUES



**Vrille sable et neige**

60 cm - 1 kg



**Piquet à frapper**

50 cm - 0.5 kg



**Pied autocal**

55 x 50 cm - 3 kg

LESTS POUR PIED



**Lest béton**

pour croix extérieure 4 kg  
ø 40 cm - 10 L



**Lest à eau**

ø 55 cm - 10 L

OPTION TENTE PLIANTE



**Fixtent**

Fixation  
pour tente



apo-snow.com

apo-snow.com



## Tente pliante Barnum

- + Pack Sublim'ò
- + Pack Nomad'ò
- + Pack Prim'ò
- + Pack Indust'ò
- + À la carte
- + Impression
- + Accessoires

100%  
PERSONNALISABLE



**PACK TOUT COMPRIS**

LES AVANTAGES

- + 100% imprimable en sublimation
- + Structure alu légère et résistante
- + Montage facile en 3 minutes
- + Transportable dans une voiture avec son sac à roulettes
- + Utilisation professionnelle : agence événementielle, associations, stands...



Tube alu hexagonal  
45mm de largeur et  
1.5mm d'épaisseur



Pièce de jonction en  
nylon haute  
densité

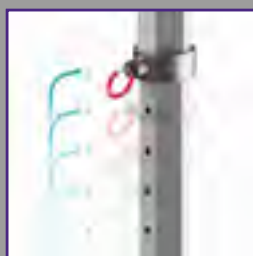

Bague de blocage pull in  
avec réglage sur 5  
niveaux de hauteur



Embase en métal  
de 11mm de largeur  
et 3mm d'épaisseur



Polyester pelliculé PVC  
300g/m<sup>2</sup> avec impression  
par sublimation

PACK TOUT COMPRIS



Structure alu45 3x3  
avec toit polyester  
imprimé



Haubanage  
sardines pro



Sac de transport  
sur roulettes

OPTIONS COMPLÉMENTAIRES

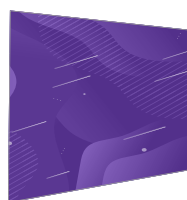

Face imprimée  
par sublimation

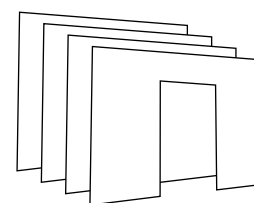

Faces latérales  
3 pleines + 1 porte



Sac de sable  
à remplir 15kg

## EXTENSION SUBLIM'O Paddock

Délimitez votre stand



### EXTENSION PERSONNALISÉE

- + Mur de fond réversible
- + 2 demi-murs avec structure

## EXTENSION SUBLIM'O SHOP

Créez un point de vente



### EXTENSION PERSONNALISÉE

- + Comptoir avec jupe personnalisée
- + Banderole de fond

## EXTENSION SUBLIM'O FULL PRINT

Le 100% personnalisé

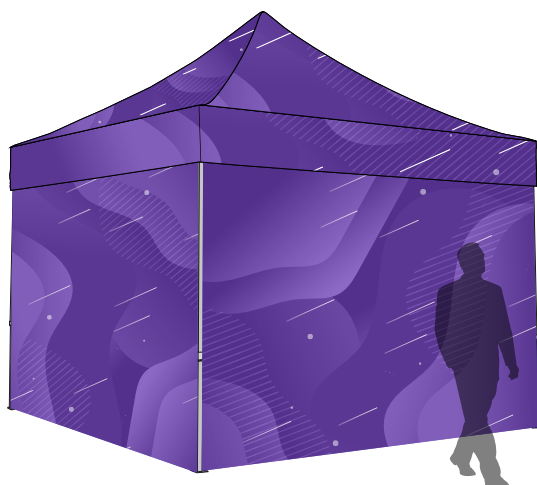

### EXTENSION PERSONNALISÉE

- + 4 murs imprimés polyester



**PACK TOUT COMPRIS**  
LES AVANTAGES

- + Structure en aluminium légère et résistante
- + Montage facile en 3 minutes
- + Transportable dans une voiture avec son sac à roulettes
- + Utilisations professionnelles : associations, commerçants...



Sac de transport



Montage en 3 mn



Sans outils



Tube alu hexagonal 45mm de largeur et 1.5mm d'épaisseur



Pièce de jonction en nylon haute densité

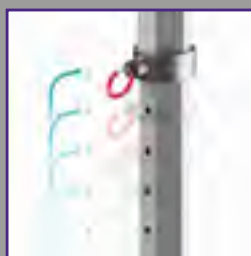

Bague de blocage pull in avec réglage sur 5 niveaux de hauteur



Embase en métal de 11mm de largeur et 3mm d'épaisseur



Polyester pelliculé PVC 300g/m<sup>2</sup> avec impression par sublimation

PACK TOUT COMPRIS

OPTIONS COMPLÉMENTAIRES



Structure alu 3x3 avec toit blanc



Haubanage sardines pro



Sac de transport sur roulettes

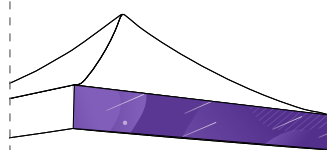

Bandeau amovible imprimé à fixer par velcro

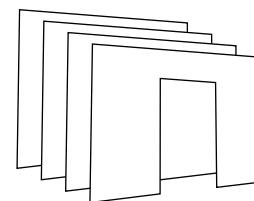

Faces latérales 3 pleines + 1 porte



4 lests en fonte de 15kg



Sac de sable à remplir 15kg



## EXTENSION NOMAD'O WINDOW

Couvrez et protégez votre stand

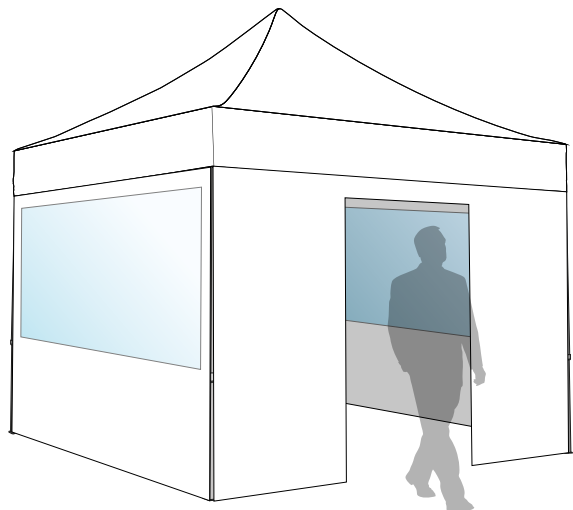

### EXTENSION PERSONNALISÉE

- + 3 murs avec fenêtre et rabat
- + 1 mur porte

## EXTENSION NOMAD'O CORNER

Rajoutez du design



### EXTENSION PERSONNALISÉE

- + 4 coins imprimés

## EXTENSION NOMAD'O FLAG

Prenez de la hauteur



### EXTENSION PERSONNALISÉE

- + 2 beachflag Plume S avec fixation
- + 1 bandeau 3m amovible



**PACK TOUT COMPRIS**

LES AVANTAGES

- + Structure en acier 32 robuste
- + Montage facile en 3 minutes
- + Transportable dans une voiture avec son sac à roulettes
- + Utilisations professionnelles : associations, commerçants...



Sac de transport



Montage en 3 mn



Sans outils



Tube acier 30mm de largeur



Pièce d'articulation centrale en acier



Bague de blocage 3 niveaux de hauteur



Embase de 60mm et 2.5mm d'épaisseur



Polyester pelliculé PVC 300g/m<sup>2</sup>

PACK TOUT COMPRIS



Structure acier 3x3 avec toit blanc



Sac de transport sur roulettes



Haubanage sardines pro

PACK PRIM'O

OPTIONS COMPLÉMENTAIRES

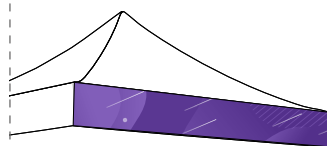

Bandeau amovible imprimé à fixer par velcro

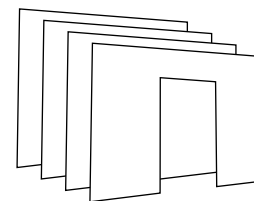

Faces latérales 3 pleines + 1 porte



4 lests en fonte de 15kg



Sac de sable à remplir 15kg

**STRUCTURE  
GARANTIE À VIE**

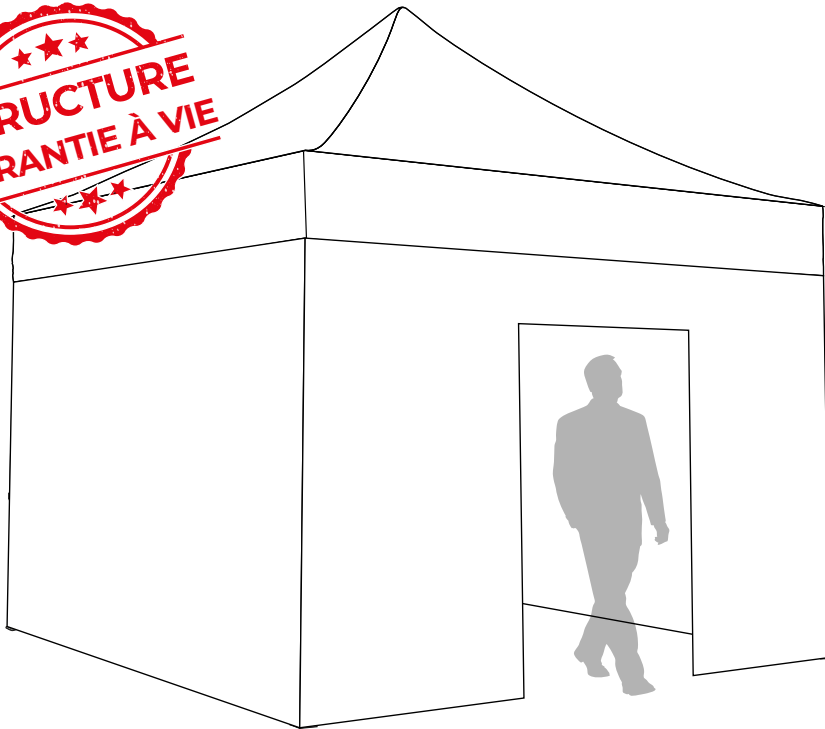

**PACK TOUT COMPRIS**  
LES AVANTAGES

- + Qualité industrielle
- + Structure garantie à vie
- + Installation semi-permanente
- + Bâche PVC 520g ignifugée M2
- + Utilisation professionnelle :  
terrasse de restaurant,  
abris de chantier,  
espace de stockage...



Sac de transport



Montage en 3 mn



Sans outils

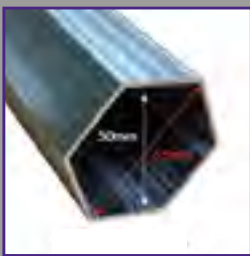

Tube alu hexagonal 55mm de largeur et 1.8mm d'épaisseur



Pièce de jonction en aluminium ultra résistant

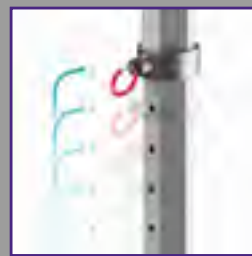

Bague de blocage pull in avec réglage sur 5 niveaux de hauteur



Embase en métal de 14mm de largeur et 3mm d'épaisseur

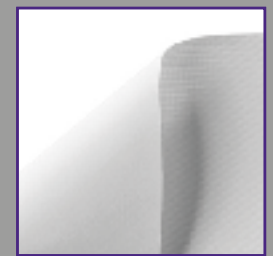

PVC 520g/m<sup>2</sup> avec ignifugation réglementée M2

PACK TOUT COMPRIS



Structure alu55 3x3 avec toit PVC 520g/m

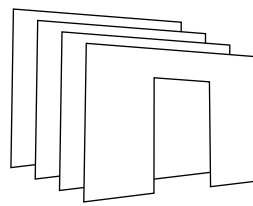

Faces PVC 3 pleines + 1 porte



Haubanage sardines pro



Sac de transport sur roulettes

OPTIONS COMPLÉMENTAIRES

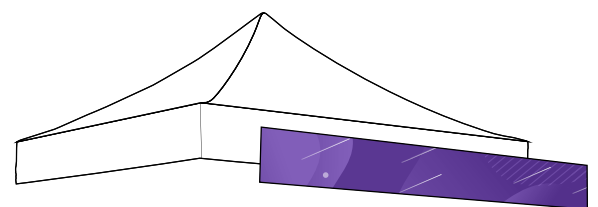

Bandeau amovible imprimé à fixer par velcro



4 lests en fonte de 15kg



Sac de sable à remplir 15kg

**LA TENTE  
HAUT DE GAMME**



**PACK TOUT COMPRIS**  
LES AVANTAGES

- + Qualité industrielle
- + Structure garantie à vie
- + Installation semi-permanente
- + Toit PVC 520g imprimé
- + Utilisation professionnelle :  
terrasse de restaurant,  
abris de chantier,  
espace de stockage...



Sac de transport



Montage en 3 mn



Sans outils

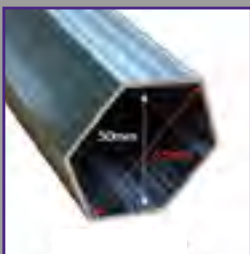

Tube alu hexagonal  
55mm de largeur et  
1.8mm d'épaisseur



Pièce de jonction en  
aluminium ultra  
résistant

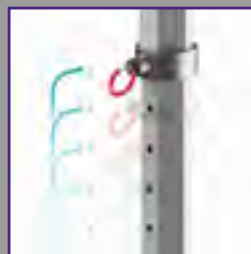

Bague de blocage pull in  
avec réglage sur 5  
niveaux de hauteur



Embase en métal  
de 14mm de largeur  
et 3mm d'épaisseur



PVC 520g/m<sup>2</sup> avec  
ignifugation  
réglementée M2

PACK TOUT COMPRIS



Structure alu55 3x3  
avec toit PVC 520g/m

PACK INDUST'O - PRINT



Haubanage  
sardines pro



Sac de transport  
sur roulettes

OPTIONS COMPLÉMENTAIRES

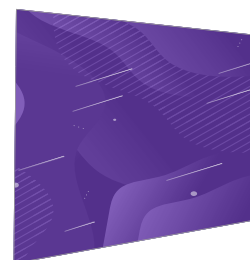

Face PVC imprimée  
par sublimation



4 lests en fonte  
de 15kg



Sac de sable  
à remplir 15kg

# TENTE À LA CARTE

Composez votre pack en fonction de vos besoins

Dimensions en m	2x2	3x3	3x4.5	3x6	4x4	5x5
ALU 55	-	✓	✓	✓	✓	✓
ALU 45	✓	✓	✓	✓	-	-
ACIER 30	-	✓	✓	✓	-	-

Toit - Coloris standards

En stock

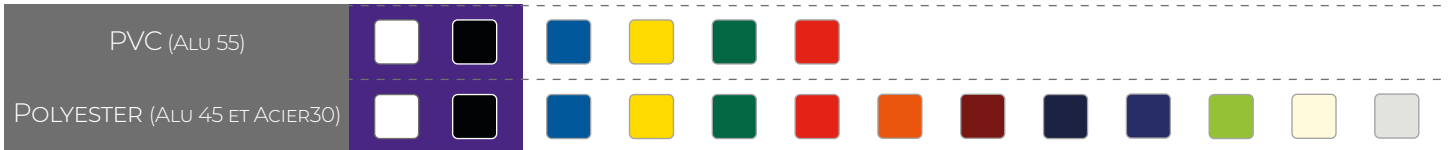

## HABILLAGE & IMPRESSION

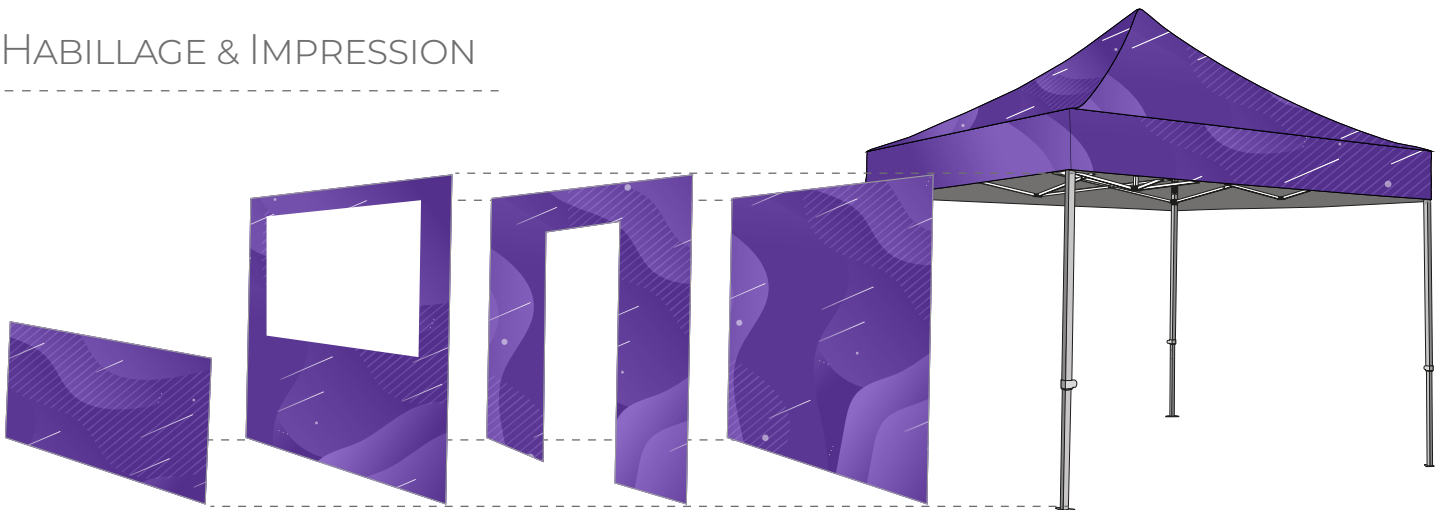

## ACCESSOIRES



**Poids de lestage**

Fonte d'acier - 15kg



**Sac de lestage**

A remplir de sable - 15kg



**Haubans**

Sardines pro + 6m de corde



**Gouttière**

3m ou 4.5m



**Chauffage**



**Eclairage LED**



**Table / comptoir**



**Jupe de table**





## Matériel gonflable étanche

- + Tente Xroof
- + Arche Stabil'o
- + Totem
- + Bouée



BREVET EU N°1504432  
USA N°7.552.555 B2



### LES AVANTAGES

- + Qualité professionnelle
- + Résiste aux conditions extrêmes
- + Air captif (sans soufflerie permanente 220 Volts)



Sac de transport



Montage en 3 mn



Sans outils



Structure en dacron pour assurer une résistance maximale

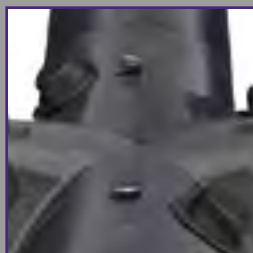

Monobloc souple 100% cousu pour éviter les matériaux rigides

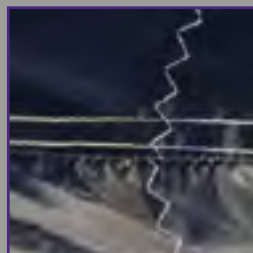

Couture en triple point cousu et renfort insigna



Chambre à air en PU 110 micros avec système « easy change »



Toit en tissu polyester étanche et ignifugé B1 pour respecter les normes

### PACK AIR PRIM'O

L'essentiel de la tente gonflable à petit prix

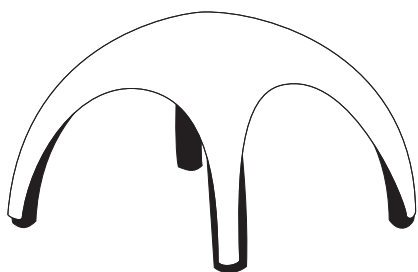

#### PACK TOUT COMPRIS

- + Structure gonflable M, L ou XL
- + Toit polyester blanc ou noir
- + Pompe 220V
- + Sac de transport

### PACK AIR RESIST'O

Un matériel de protection durable et qualitatif

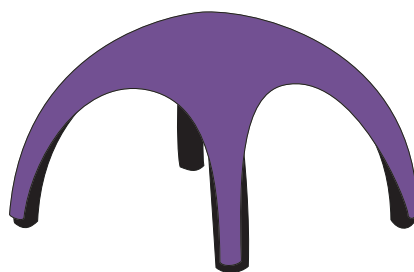

#### PACK TOUT COMPRIS

- + Structure gonflable M, L ou XL
- + Toit polyester coloris standard
- + Pompe 220V
- + Sac de transport

### PACK AIR DEC'O

Un outil de communication nomade et tendance



#### PACK TOUT COMPRIS

- + Structure gonflable M, L ou XL
- + Toit polyester 100% imprimé
- + Pompe 220V
- + Sac de transport



## OPTIONS D'IMPRESSION DISPONIBLES

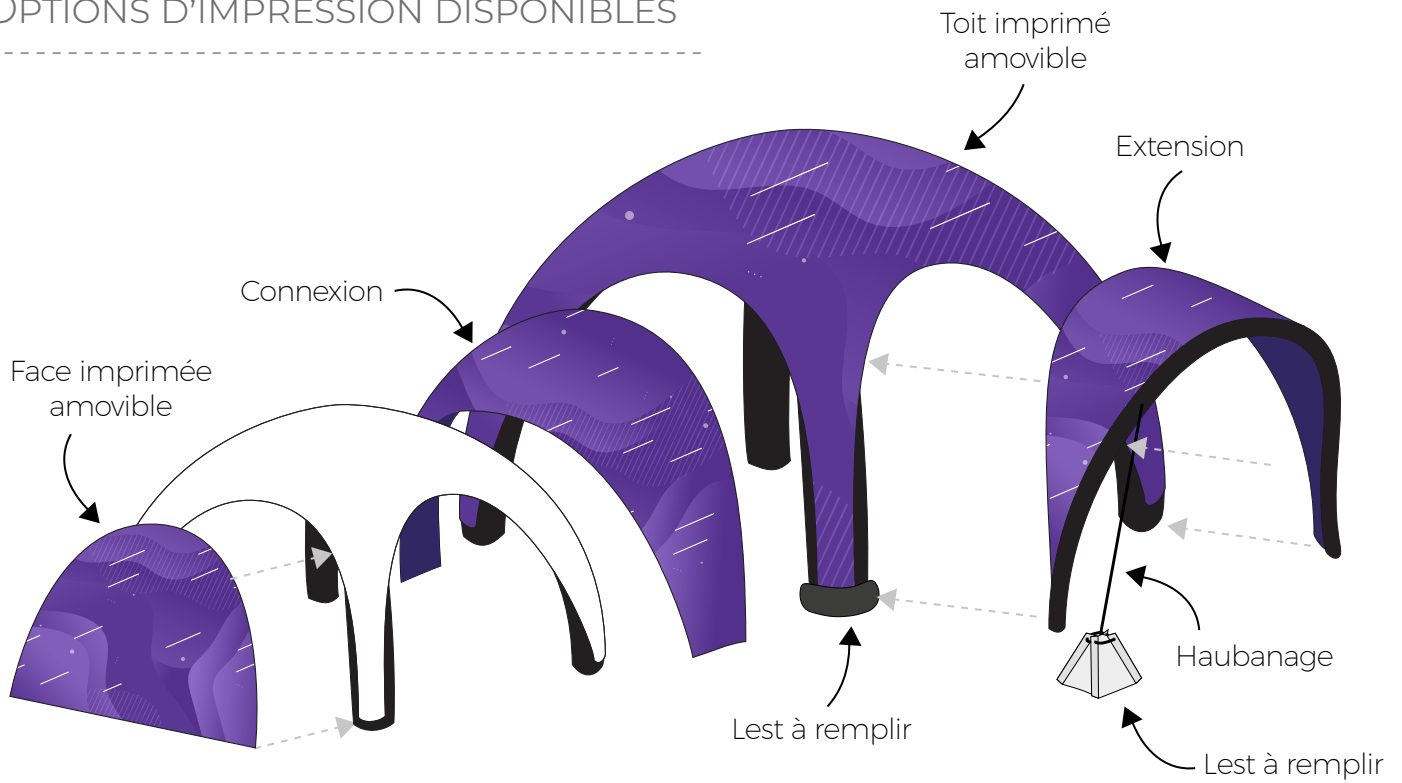

Tailles en m	M3	L4	XL5
SURFACE	9m <sup>2</sup>	16m <sup>2</sup>	25m <sup>2</sup>
HAUTEUR	2.64	3.25	4.94
PORTE	2.11	2.57	3.1

## ACCESSOIRES



**Sac de transport**



**Sac de lestage**  
15kg - A remplir



**Haubanage**  
x4



**Sardines et piquets**  
pour sol meuble ou mixte



**Pompe manuelle**



**Pompe 12V**  
Sur batterie



**Pompe 220V**

LES AVANTAGES

- + Qualité professionnelle
- + Résiste au vent
- + Léger et pratique
- + Impression directe ou amovible
- + Air captif (sans soufflerie permanente 220 Volts)

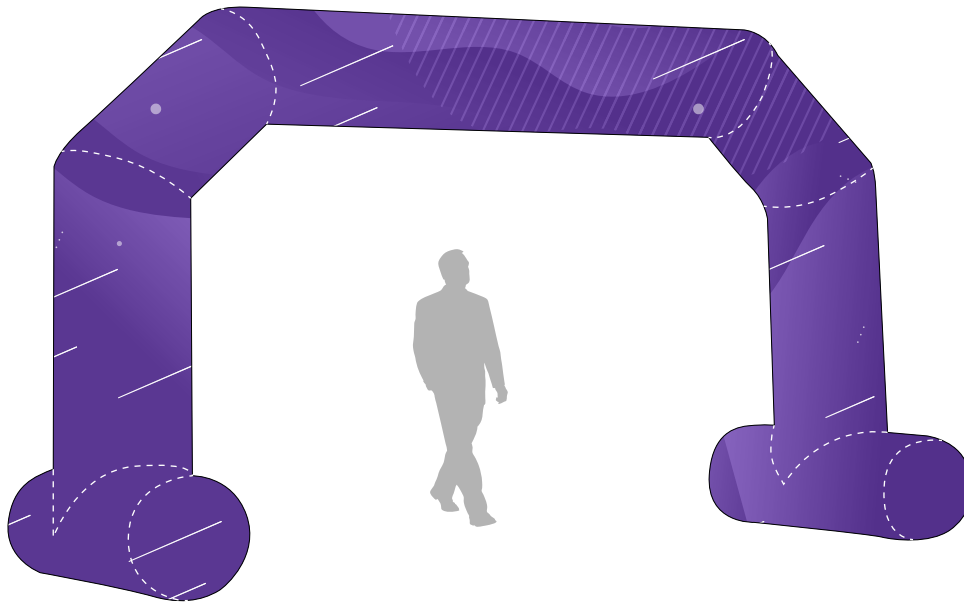

Sac de transport



Montage en 3 mn



Sans outils



Structure en PVC 680 g/m<sup>2</sup> parfaitement étanche



Plusieurs points d'encrage pour plus de résistance

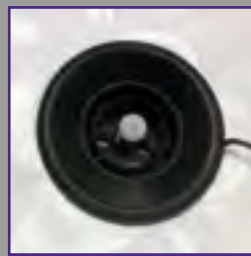

Valve anti retour haut débit



Impression latex directement sur le PVC sur demande



Bandeaux amovibles fixés par velcro avec impression sublimation

NOMBREUSES OPTIONS

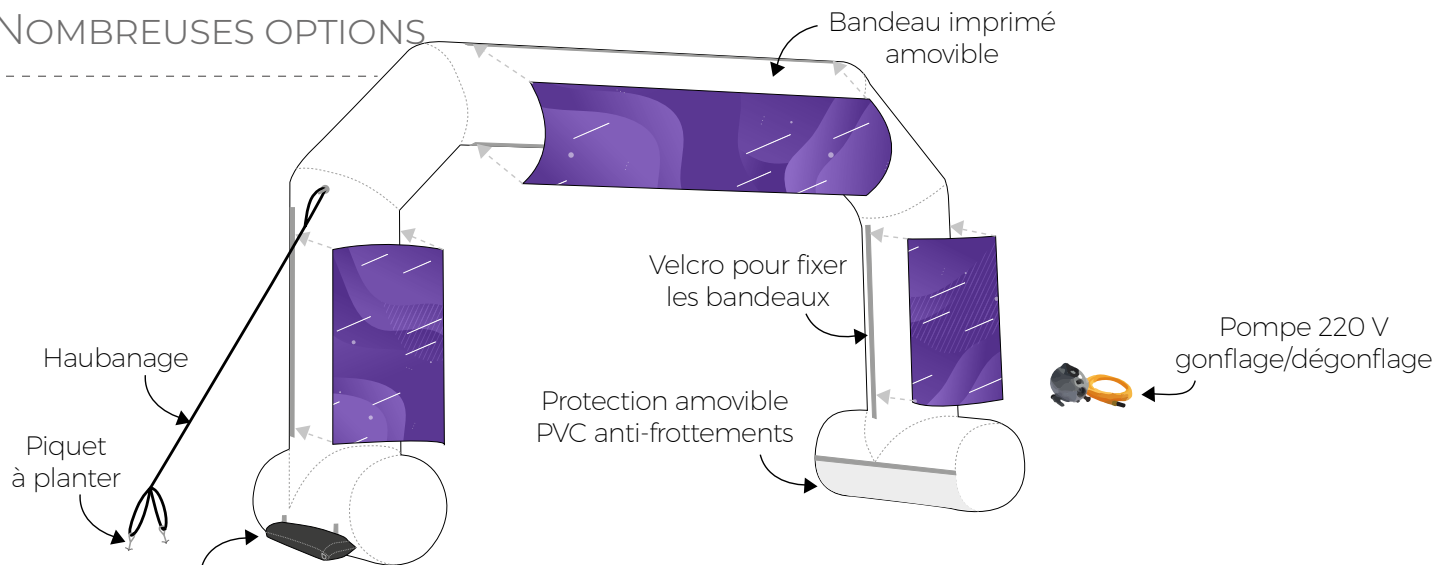

Tailles en m

	S3	M5	L6	XL8
DIMENSIONS EXTÉRIEURES	4.6 x 3	6.6 x 4.3	8 x 5	10 x 5
DIMENSIONS INTÉRIEURES	3 x 2.2	5 x 3.5	6 x 4	8 x 4

## FORMES

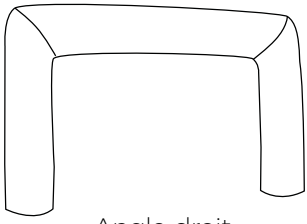

Angle droit  
Sans T foot

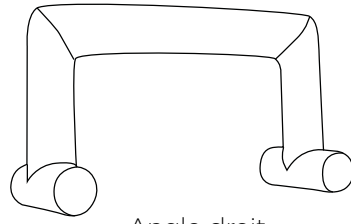

Angle droit  
Avec T foot

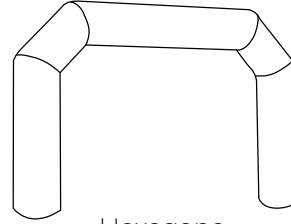

Hexagone  
Sans T foot

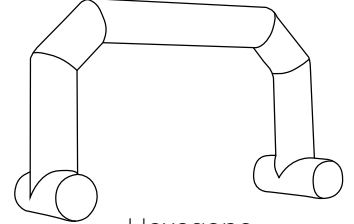

Hexagone  
Avec T foot

## IMPRESSION & PERSONNALISATION

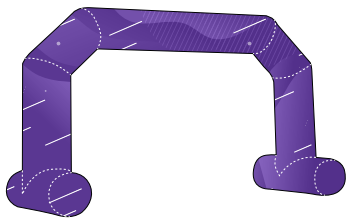

100% imprimé

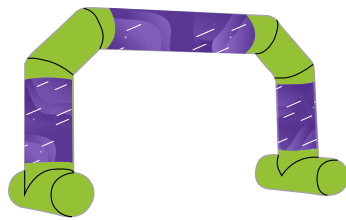

Couleur standard  
avec bandeaux

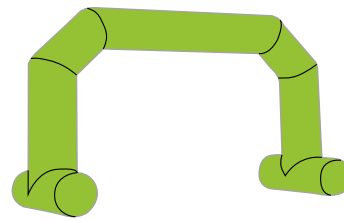

Couleur standard  
sans personnalisation

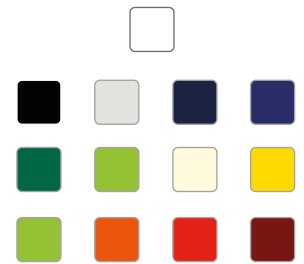

Coloris standards

## FIXATIONS



Kit haubanage

x4



Sac de lestage

15kg - A remplir



Sardines et piquets

pour sol meuble ou mixte

## GONFLAGE



Pompe manuelle



Pompe 12V

Sur batterie



Pompe 220V

# TOTEM GONFLABLE

Ultra nomade pour une visibilité 360°



## LES AVANTAGES

- + Qualité professionnelle
- + Résiste aux conditions extrêmes (vent 90km/h)
- + Air captif (sans soufflerie permanente 220 Volts)



Sac de transport



Montage en 3 mn



Sans outils

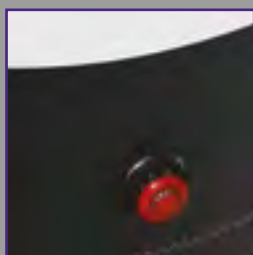

Structure en polyester et PVC équipée de valves de surpression



Monobloc souple 100% cousue pour éviter les matériaux rigides



Chambre à air en PU 110 micros avec système « easy change »



Rétro éclairage LED en option pour les événements nocturnes



Tissu polyester 210g élastique avec impression sublimation

## IMPRESSION & ACCESSOIRES

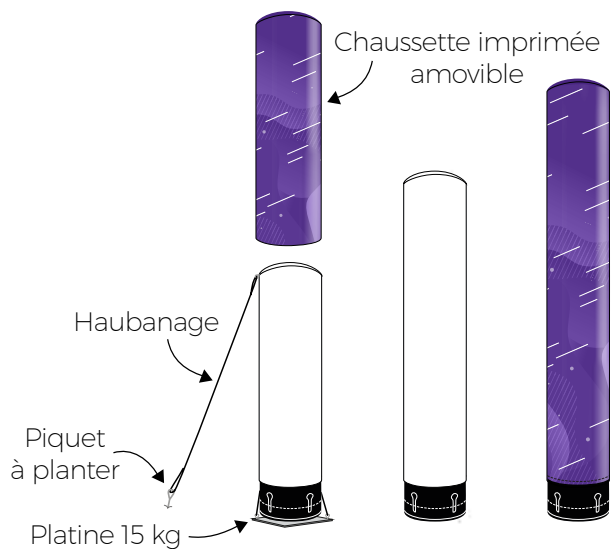

## FIXATIONS



Platine intérieure  
5kg



Platine extérieure  
15kg

TOTEM

Tailles en m	2m	3m	4m
HAUTEUR DU VISUEL	1.8	2.8	3.8
DIAMÈTRE	0.5	0.5	0.5

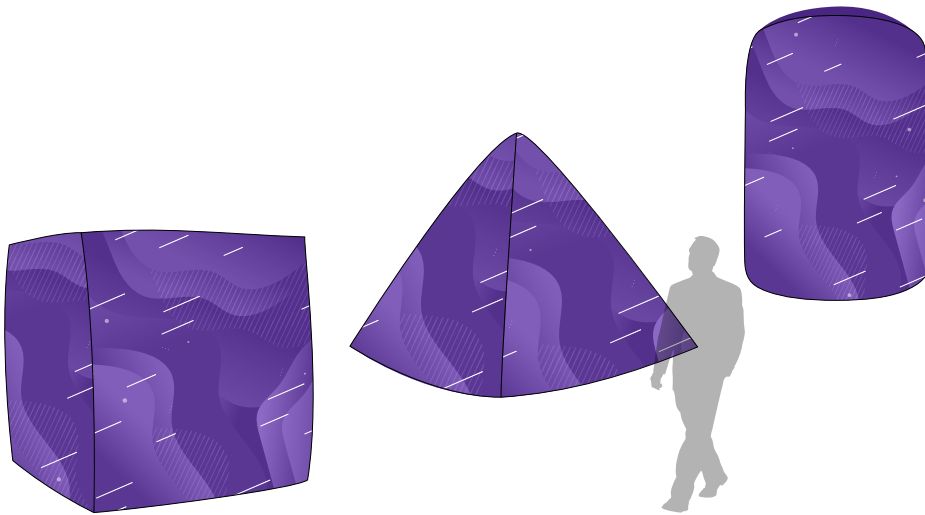

LES AVANTAGES

- + Qualité professionnelle
- + Résiste aux conditions extrêmes
- + Air captif (sans soufflerie permanente 220 Volts)



Sac de transport



Montage en 3 mn



Sans outils



Structure en PVC 680 g/m<sup>2</sup> parfaitement étanche

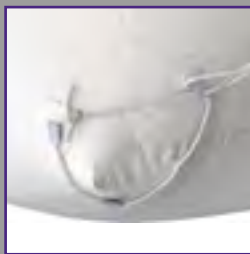

Plusieurs points d'encrage pour plus de résistance



Valve anti retour haut débit



Impression latex directement sur le PVC sur demande



Bandeaux amovibles fixés par velcro avec impression sublimation

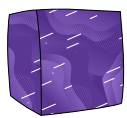

Forme Cube

Tailles en m

	M	L	XL
LARGEUR	1	1.5	2
HAUTEUR	1	1.5	2

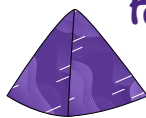

Forme Pyramide

Tailles en m

	M	L	XL
LARGEUR	1.4	2.15	2.9
HAUTEUR	1	1.5	2



Forme Cylindre

Tailles en m

	S	M	L	XL
LARGEUR	0.5	1	1	1.2
HAUTEUR	0.8	1	1.5	1.8

OPTIONS D'IMPRESSIION

Impression directe

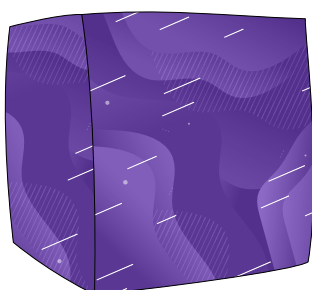

Impression amovible

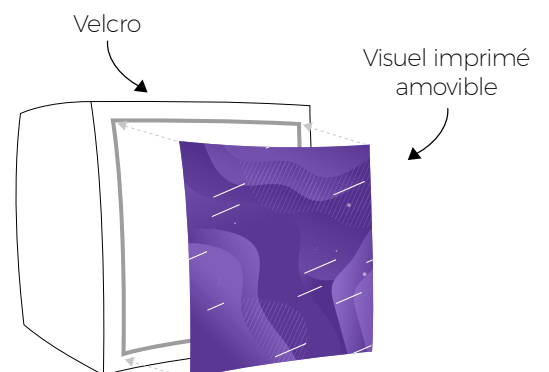



**DECATHLON**

**DECATHLON**

**DECATHLON**



# Pavillonnerie

- + Drapeau pour potence de rue
- + Drapeau pour mât potence
- + Drapeau pour mât droit
- + Guirlande de fanions
- + Supporters et Tifo
- + Sur mesure



### LES AVANTAGES

- + Fixations murales ou sur poteaux
- + Sur mesure ou standard
- + Parfait pour l'extérieur
- + Résistant sur la durée
- + Visuel interchangeable



Structure ultra résistante conçue pour l'extérieur en aluminium anti-rouille



Potences en fibre de verre et Epoxy de 15mm de diamètre



Fourreaux renforcés haut et bas pour insérer le visuel



S'adapte à tous types de poteaux grâce au système de fixation réglable



Maille drapeau 110g micro-perforée impression sublimation

### Sur potences

Taille en cm

S M L XL

LARGEUR	60	75	90	75
HAUTEUR	120	150	150	210

### AUTRES SUPPORTS D'IMPRESSION

STREET KAKEMONO



Maille standard Polyester 115g



PVC Standard 450g



Micro perforé PVC 330g

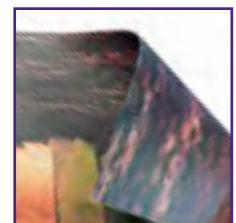

Recto verso PVC 450g



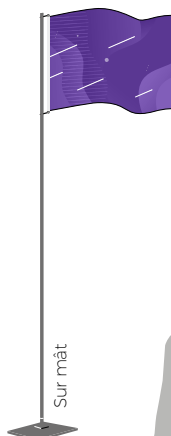
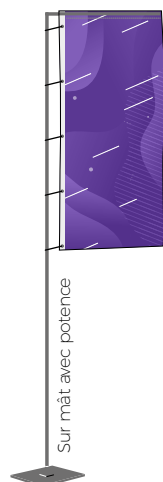
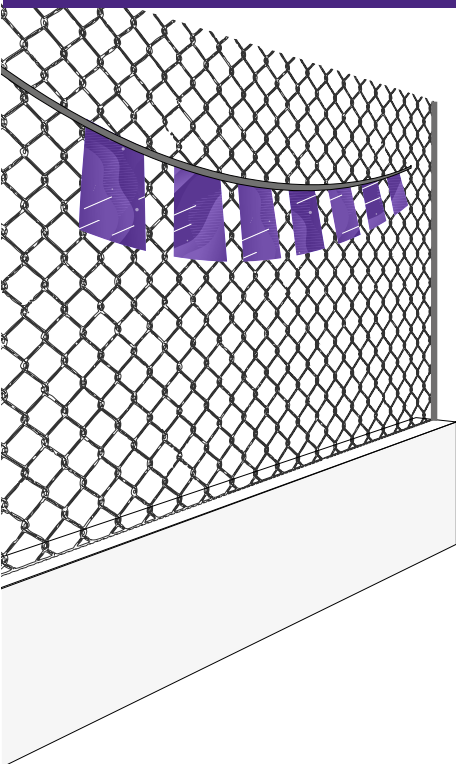

## LES AVANTAGES

- + Sur mesure ou standard
- + Intérieur et extérieur
- + Nombreuses finitions
- + Impression sublimation

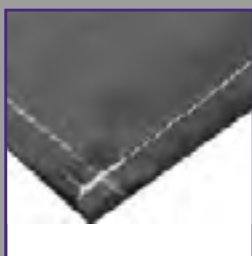

Ourlet tout autour pour une finition qualitative

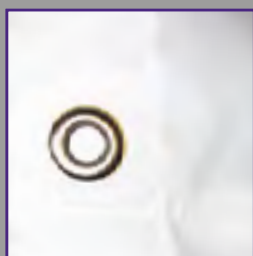

Renfort avec oeillet pour attacher ou lester le visuel



Fourreau sur mesure pour s'adapter à votre structure



Sangle avec anneaux pour accrocher le pavillon partout

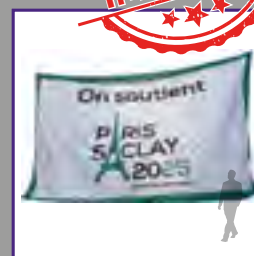

Polyester maille bloquée 115g/m<sup>2</sup> avec impression par sublimation

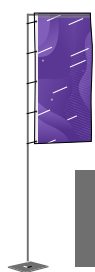

### Sur mât

Tailles en cm

S L

LARGEUR	40	120
HAUTEUR	30	80



### Avec mât et potence

Taille en cm

L

LARGEUR	100
HAUTEUR	300



### Guirlande 10m ~ 50 pavillons

Taille des fanions en cm

LARGEUR	20
HAUTEUR	30



### Supporter

Taille des pavillons en cm

LARGEUR	30
HAUTEUR	20

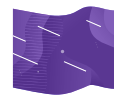

### Tifo

Taille en cm

LARGEUR	500
HAUTEUR	300





## Impression grand format

- + Bâches PVC
- + Banderoles tissus
- + Panneaux rigides
- + Covering adhésif
- + Affiche papier



# BANDEROLES & BÂCHES PVC

Affichez-vous partout

## LES AVANTAGES

- + Sur mesure ou standard
- + Intérieur et extérieur
- + Nombreuses finitions
- + Qualité HD

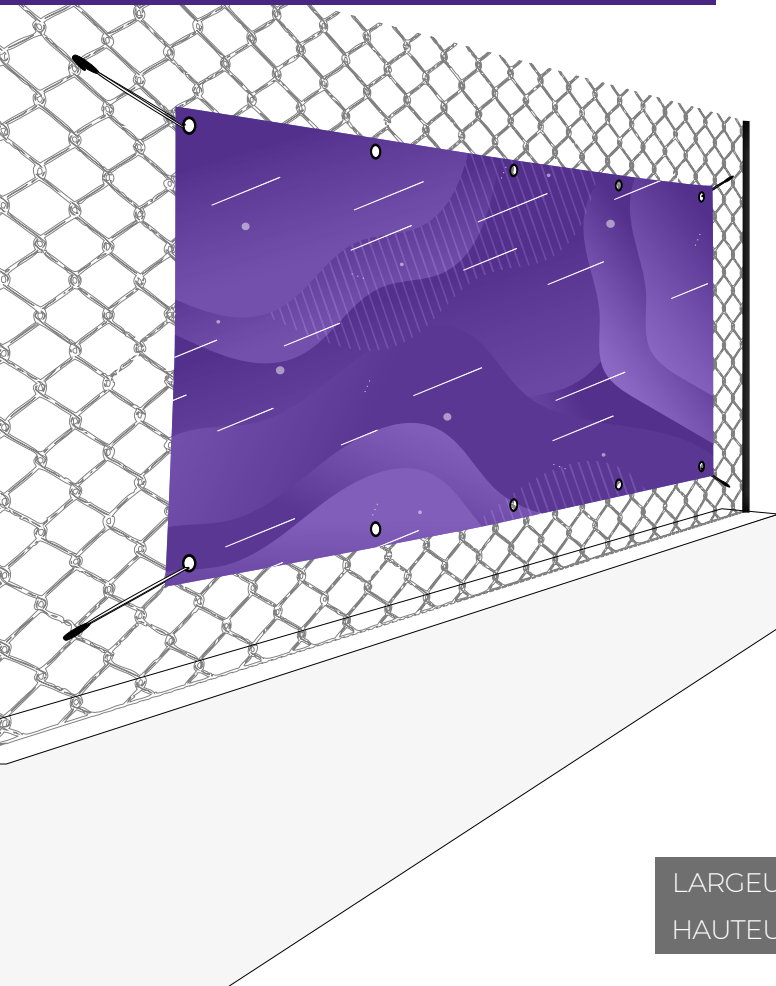

Disponible en diffusant pour rétro éclairage

### Bâches standards

Tailles en cm

	S	L	Vauban
LARGEUR	200	300	250
HAUTEUR	80	100	90



PVC

FINITIONS



Premium 650g  
ignifugé  
option recto verso



Standard 450g  
option ignifugé



Eco 440g

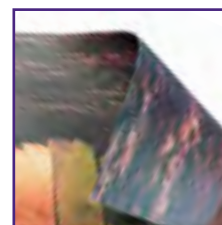

Recto verso



Renfort



Oeillets



Sandows



Fourreaux



Velcro

BANDEROLES & BÂCHES PVC

## MICRO-PERFORÉS



Premium 350g  
ignifugé



Standard 330g



Eco 270g

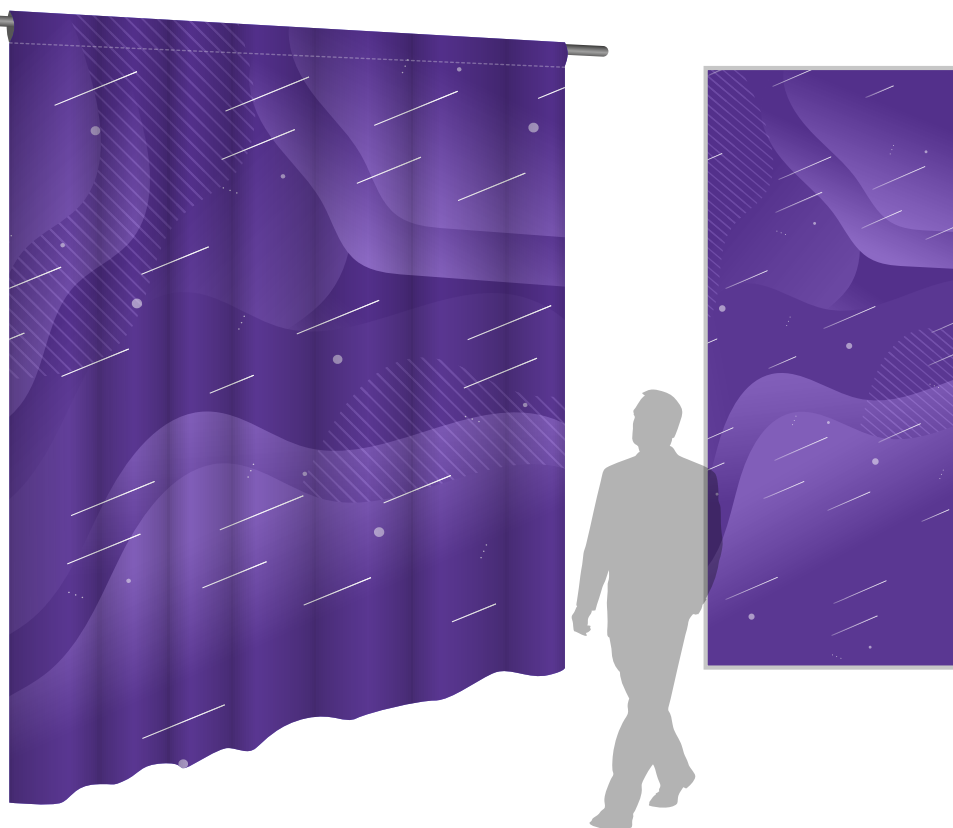

LES AVANTAGES

- + Sur mesure
- + Intérieur et extérieur
- + Ephémère ou permanent
- + Qualité HD

Rouleau  
au m<sup>2</sup>



POLYESTERS



Polyester 115g  
drapeau

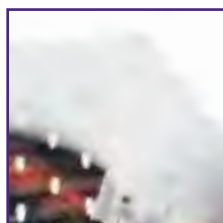

Polyester 100g  
drapeau perforé



Polyester 180g  
nappe et rideau



Polyester 210g  
mur d'image

FINITIONS



Oeillets



Fourreaux



Joint silicone

SPÉCIFIQUES



Intissé 150g  
banderole  
éphémère

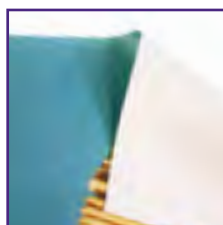

Airtex 330g  
banderole  
durable

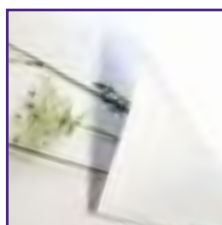

Diffusant IN 260g  
cadre lumineux  
intérieur



Diffusant OUT 195g  
cadre lumineux  
extérieur

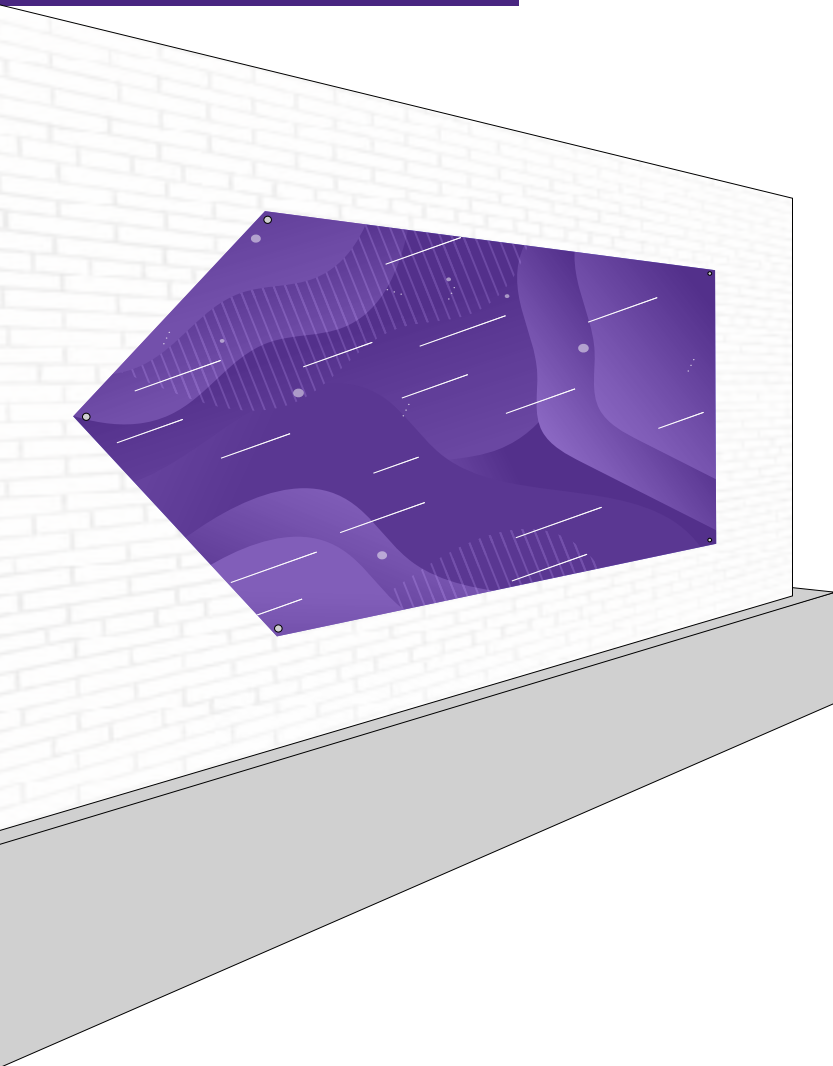

LES AVANTAGES

- + Sur mesure ou standard
- + Découpe à la forme
- + Intérieur et extérieur
- + Qualité photo

Panneaux standards

Tailles en cm

	S	L	XL
LARGEUR	60	800	1200
HAUTEUR	40	60	100

PLEXIGLAS

Recto seul et blanc de soutien

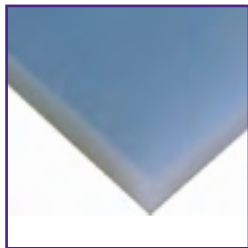

3mm

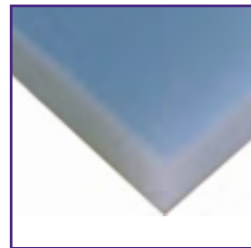

5mm

Recto / verso

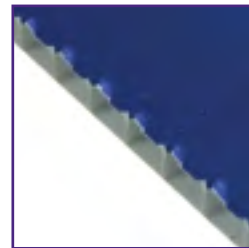

3mm

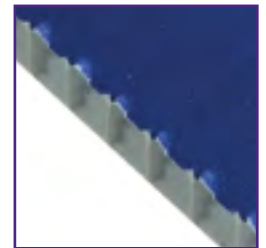

5mm

AKILUX

PANNEAUTIQUE ET ENSEIGNES RIGIDES

FOREX



3mm



5mm



10mm

Recto / verso

Recto / verso

DIBOND

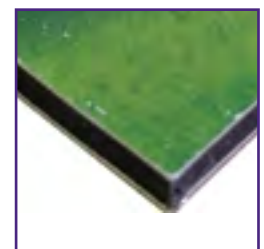

3mm

LES AVANTAGES

- + Sur mesure
- + Véhicule, sol, mur, vitrine...
- + Ephémère ou permanent
- + Qualité photo

Rouleau au m<sup>2</sup>

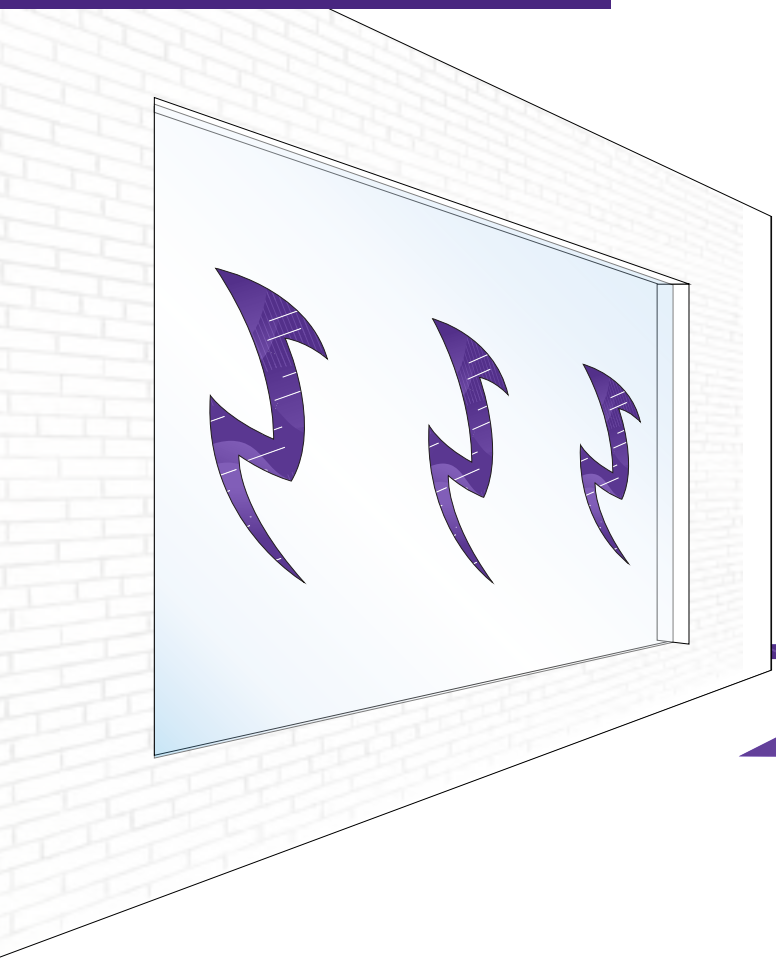

ADHÉSIFS

AFFICHAGE



Monomère brillant



Monomère mat

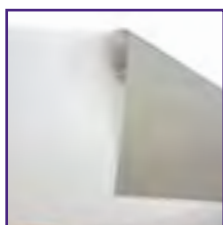

Polymère brillant

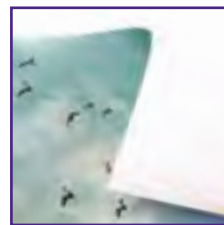

Standard 150g



Photo 200g

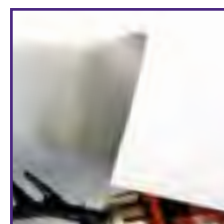

Ecoflat 220g

SPÉCIAUX



Micro-perforé



Repositionnable

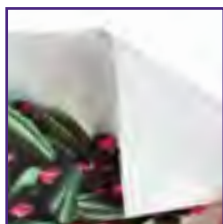

Anti-dérapant

PRO  
2LOCAL

LE RENDEZ-VOUS  
BUSINESS & MÉTIERS  
DE L'ALIMENTAIRE

# METIERS PASSION



Boulangier(e)

Sommelier(e)

Fromager(e)



**INSTANT PHOTO**

La filière alimentaire propose différents métiers, très différents, recréés par les entreprises.

**SOUVENIR DES MÉTIERS-PASSION!**

CHANGE-TOI  
MÉTIERE DE JOUR

PRO  
2LOCAL





## Mur d'image

- + Mur Pop-Up
- + Mur tubulaire
- + Photocall
- + Cadre lumineux
- + Cadre aluminium
- + Enseigne aluminium

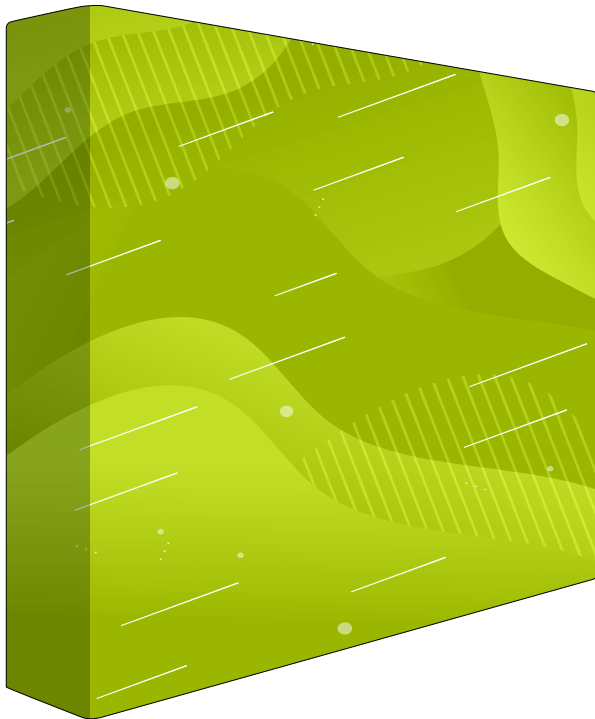

## LES AVANTAGES

- + Déploiement en 30 sec
- + Large surface d'impression
- + Se transporte partout
- + 2 fois moins lourd que les stands parapluie classiques PVC
- + Impression par sublimation



Sac de transport



Monobloc léger



Sans outils



Structure pliable monobloc avec visuel à fixer par velcro



Pièce de jonction des croisillons pour un déploiement facile



Tube aluminium 12mm renforcé avec connecteurs de maintien à clipser



Sac de rangement pour le transporter facilement partout



Tissu polyester 230 g/m<sup>2</sup> avec impression par sublimation



### Forme Droite

Taille en cm

**3x3**    **4x3**

LARGEUR	223	269
HAUTEUR	223	223
POIDS EN KG	7	9.7

Option éclairage LED à fixer



## MONTAGE EN 3MN

MUR D'IMAGE POP-UP

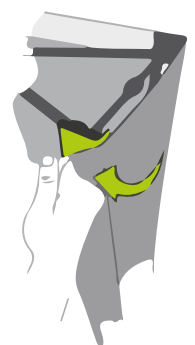
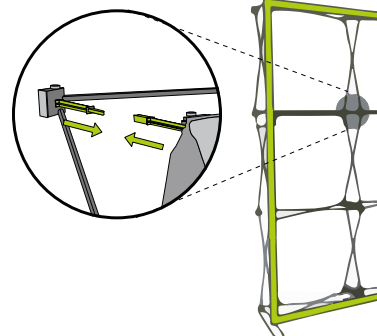
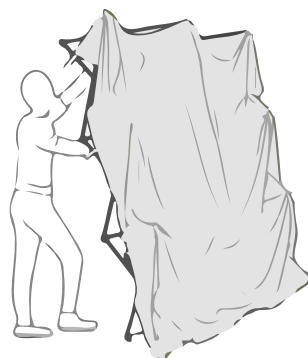

## MUR TUBULAIRE

## Le mur d'image à monter



Structure compatible avec la gamme des socles de drapeau pour un usage en extérieur

### LES AVANTAGES

- + Montage simple et rapide
- + Donne de la profondeur à votre stand
- + Qualité photo
- + Visuel changeable



Sac de transport



Ultra léger



Sans outils



Structure tubulaire en aluminium de 3cm de diamètre



Compatible avec les socles de la gamme drapeau



Segments reliés par un élastique



Sac de transport pour le ranger et le stocker facilement



Tissu polyester avec impression par sublimation



### Formats standards

Tailles en cm

	S	M	L	XL
LARGEUR	85	120	245	295
HAUTEUR	228	228	228	228

Autres tailles et formes sur demande

### MONTAGE EN 5MN

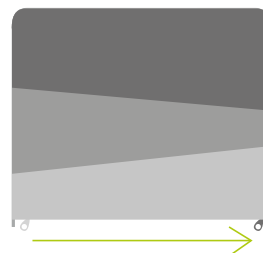

MUR TUBULAIRE



LES AVANTAGES

- + Montage simple et rapide
- + Structure télescopique pour s'adapter à l'espace
- + Visuel changeable en PVC ou Polyester avec possibilité de découpe pour visage



Sac de transport



Ultra léger



Sans outils

Structure compatible avec la gamme des socles de drapeau pour un usage en extérieur

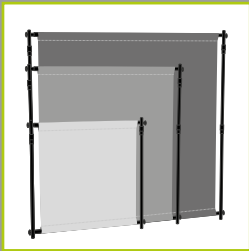

Structure adaptable en hauteur et en largeur pour optimiser l'espace



Tube aluminium de 25mm de diamètre avec bague de serrage



Compatible avec les socles de la gamme drapeau



Sac de transport pour le ranger et le stocker facilement



Visuel en tissu polyester 230g/m<sup>2</sup> ou PVC 450g/m<sup>2</sup>



Photocall

Tailles en cm

Minimum Maximum

LARGEUR	90	300
HAUTEUR	90	300

FINITIONS DISPONIBLES



Fourreaux



Oeillets

MONTAGE EN 5MN

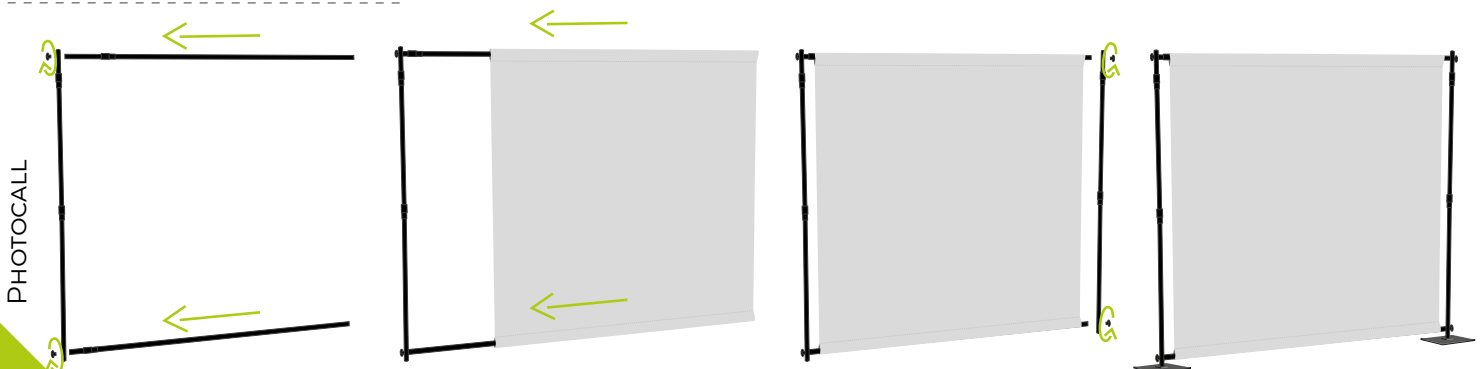

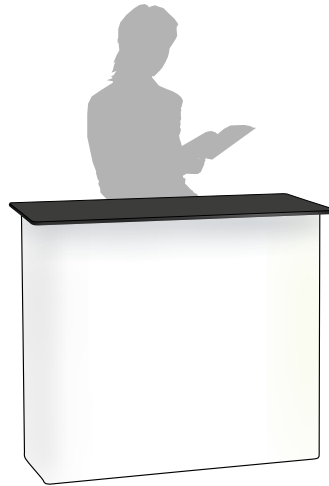

### LES AVANTAGES

- + Eclairage diffusant optimal
- + Montage express
- + Taille sur mesure
- + Conception fixe ou nomade
- + Impression par sublimation



Sac de transport



Sans outils



Segments avec easy clic pour un montage rapide (tailles S et M)



Profilé aluminium de 15mm d'épaisseur et 75mm de largeur



Sac de transport avec mousse pour protéger la structure



Eclairage LED à connecter facilement sans outil



Visuel polyester 230g/m<sup>2</sup> interchangeable avec impression sublimation



### Formats standards

Tailles en cm

	S	M	L	XL
LARGEUR	85	100	200	300
HAUTEUR	200	200	225	225

### MONTAGE FACILE & EXPRESS

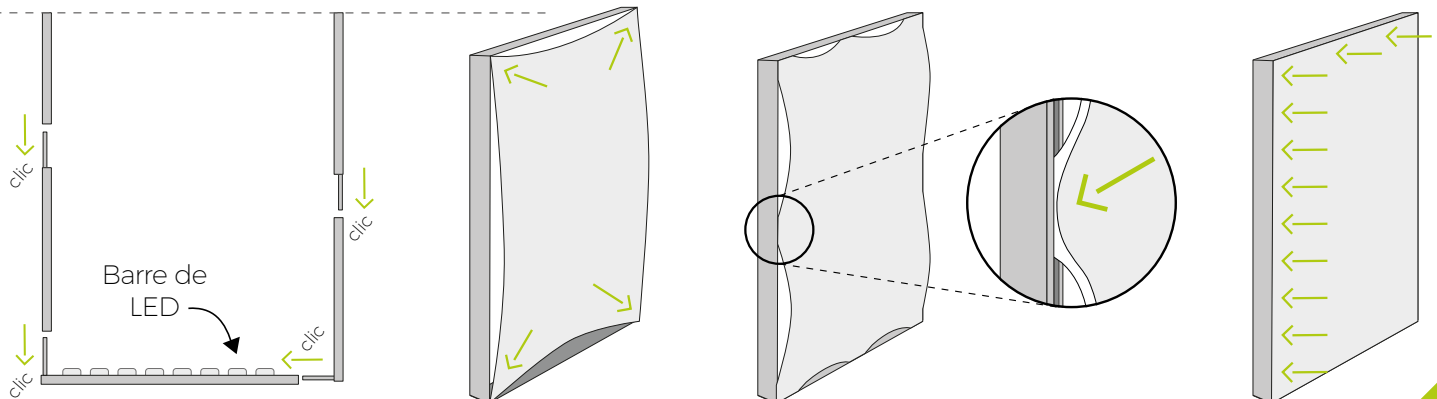

CADRE LUMINEUX

### LES AVANTAGES

- + Large surface d'impression
- + S'adapte à votre communication
- + Taille sur mesure
- + Conception fixe ou nomade
- + Impression par sublimation



Sac de transport



Sans outils



Segments emboîtables avec easy clic pour un montage rapide



Profilé aluminium de 15mm d'épaisseur et 75mm de largeur



Sac de rangement avec roulettes pour faciliter le transport

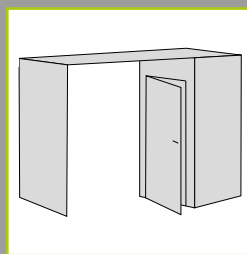

Nombreuses possibilités d'aménagement : arche, porte, réserve...



Visuel polyester 230g/m<sup>2</sup> interchangeable avec impression sublimation



### Formats standards

Tailles en cm

	S	M	L	XL
LARGEUR	85	120	245	295
HAUTEUR	228	228	228	228

### MONTAGE FACILE & EXPRESS

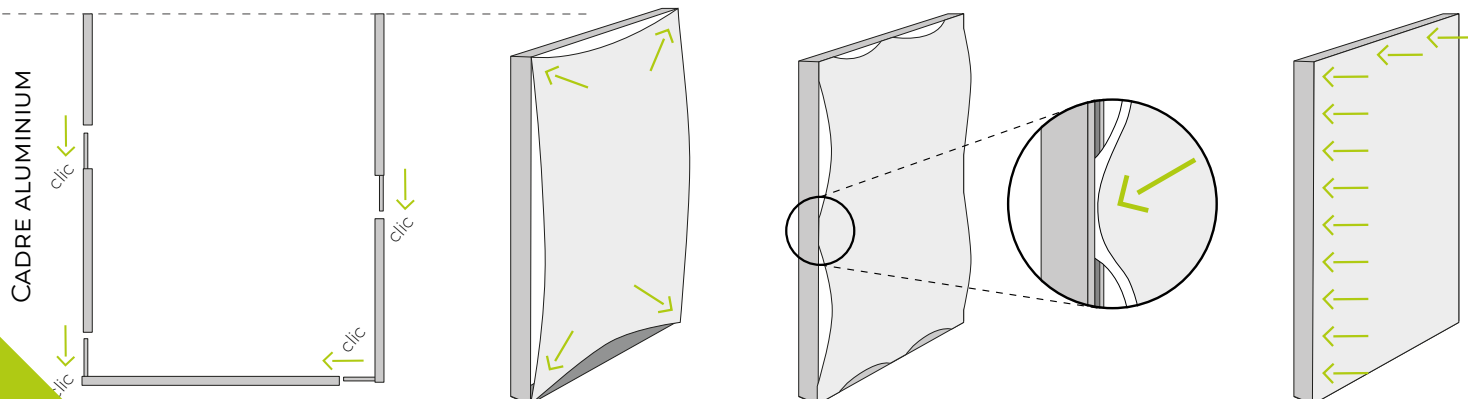

# ENSEIGNE ALUMINIUM

Changez votre enseigne en 2 minutes



## LES AVANTAGES

- + Cadre rigide pour une pose facile
- + S'adapte à votre communication
- + Taille sur mesure
- + Intérieur / extérieur
- + Impression par sublimation



Ultra léger



Profilé aluminium de 15mm d'épaisseur et 25mm de largeur



Kit d'accroche pour une pose facile inclus



Equerre de serrage pour les angles de la structure

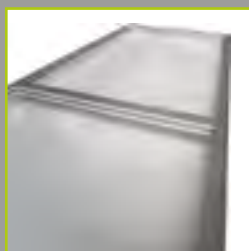

Barre de renfort centrale pour un maintien parfait



Visuel polyester 230g/m<sup>2</sup> interchangeable avec impression sublimation



## Formats standards

Tailles en cm

	S	M	L	XL
LARGEUR	85	120	245	295
HAUTEUR	228	228	228	228

## MONTAGE FACILE

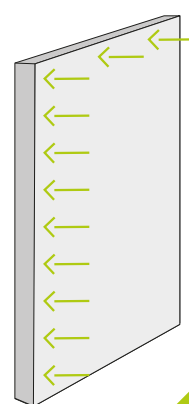
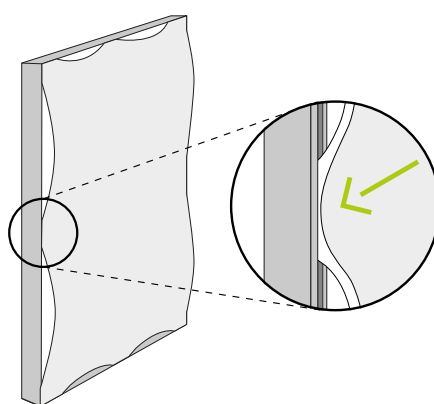
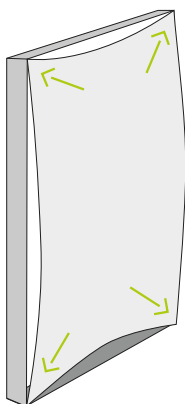
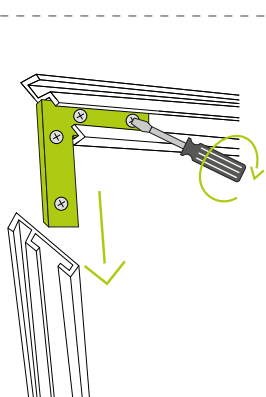

ENSEIGNE ALUMINIUM







## Affichage fixe et Décoration

- + Table flag
- + Drapeaux promotionnels
- + Suspensions Pop-Up
- + Suspensions tubulaires
- + Sky Dancer
- + Stop trottoir



LES AVANTAGES

- + Attire le regard
- + Montage facile
- + Economique
- + Embase et sac inclus



Sac de transport



Ultra léger



Sans outils



Stabilité garantie grâce à son embase



Sommet renforcé pour protéger et enfiler la voile facilement

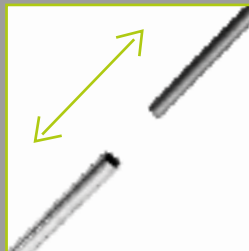

Mât emboîtable



Format mini pour le transporter facilement partout



Polyester maille bloquée 115 g/m<sup>2</sup> avec impression par sublimation



Table flag

Tailles en cm

HAUTEUR 48

LARGEUR 15

MONTAGE EN 30 SEC

TABLE FLAG

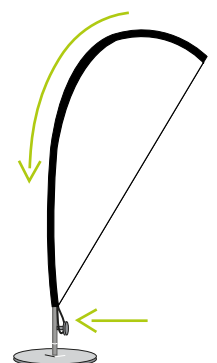
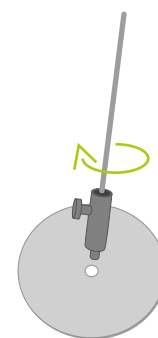
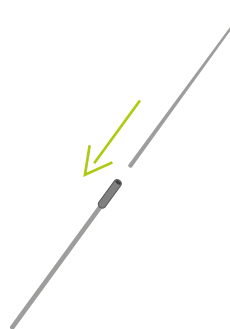
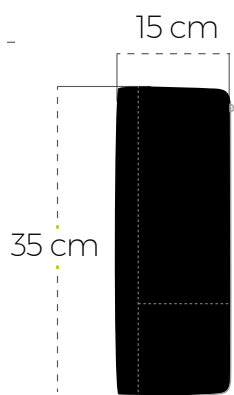
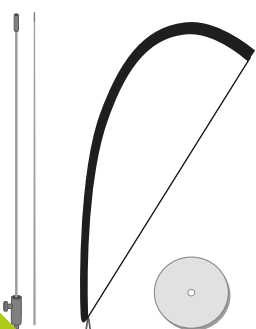



LES AVANTAGES

- + Attire le regard
- + Balise votre linéaire
- + Léger et pratique
- + Qualité photo

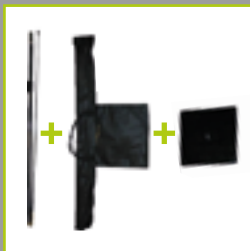

Kit tout compris  
mât + voile + socle  
dans sa housse



Sommet renforcé pour  
protéger et enfiler  
la voile facilement



Mât renforcé et  
emboîtable, relié  
par un élastique



Structure en E-glass  
pour allier souplesse  
et solidité



Polyester maille bloquée  
115 g/m<sup>2</sup> avec impression  
par sublimation



Forme Sea

Taille en cm

Maxi

MÂT	200
VOILE	50x176

MONTAGE EN 30 SEC

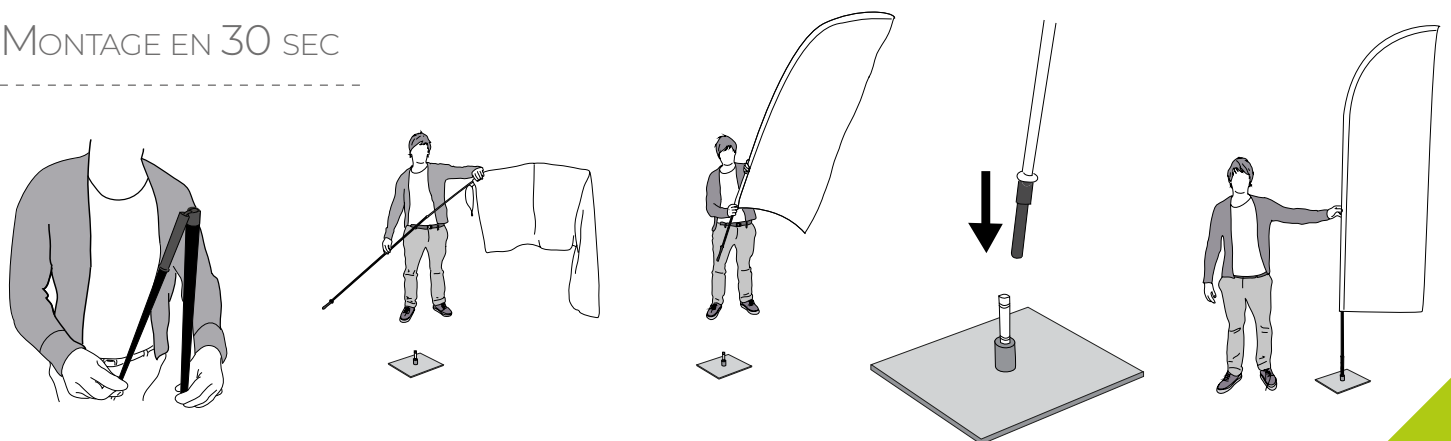

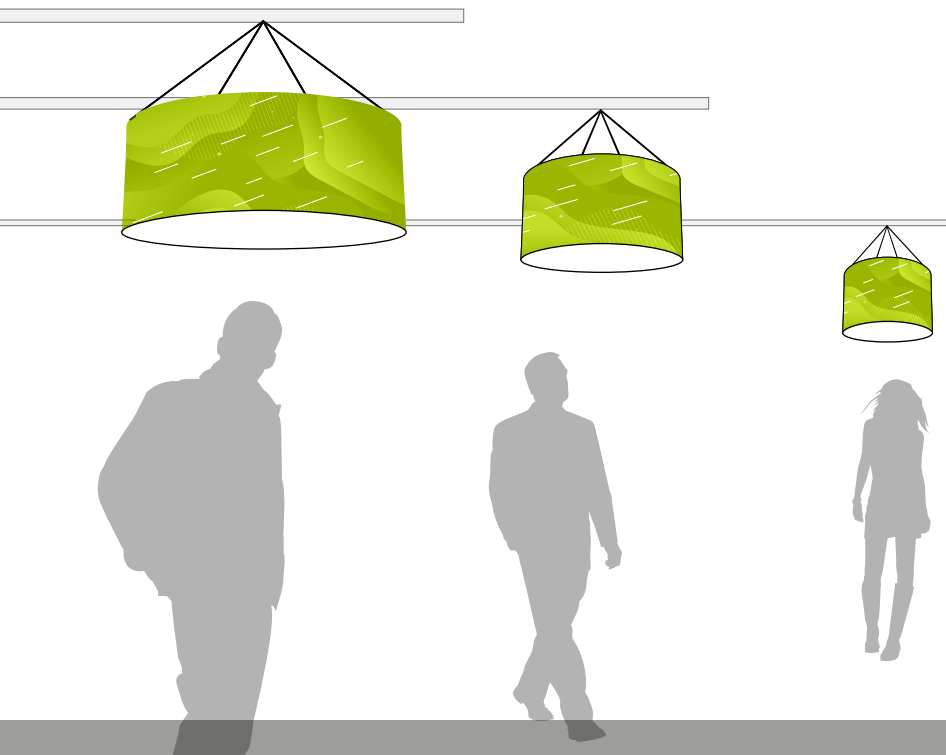

LES AVANTAGES

- + Attire le regard de loin
- + Léger et pratique
- + Qualité photo
- + Visibilité 360°



Sac de transport



Ignifugé B1



Sans outils

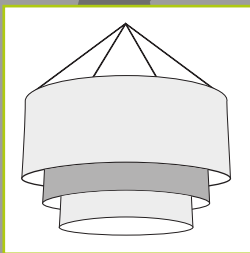

Modèles superposables pour aménager l'espace



Sac de rangement pour la transporter facilement

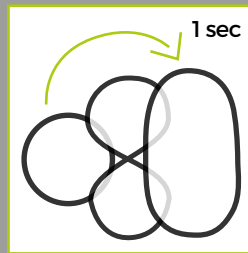

S'auto-déplie pour une installation instantanée



Structure en fibre de verre pour plus de souplesse dans le pliage



Polyester maille bloquée 200 g/m<sup>2</sup> avec impression par sublimation

Forme Cylindrique

Structure pliable

Tailles en cm

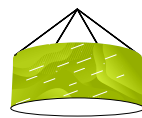

	S	M	L	XL
DIAMÈTRE	80	150	180	180
HAUTEUR	80	80	80	140

SUSPENSIONS POP-UP

MONTAGE ET  
INSTALLATION  
5 SECONDES

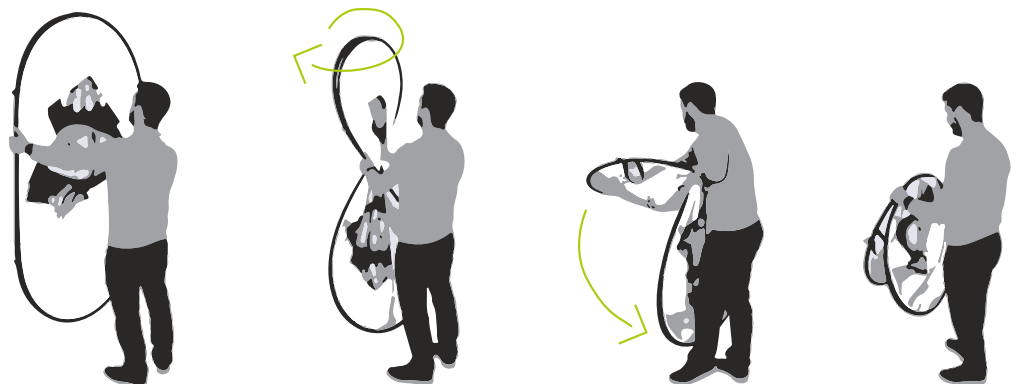

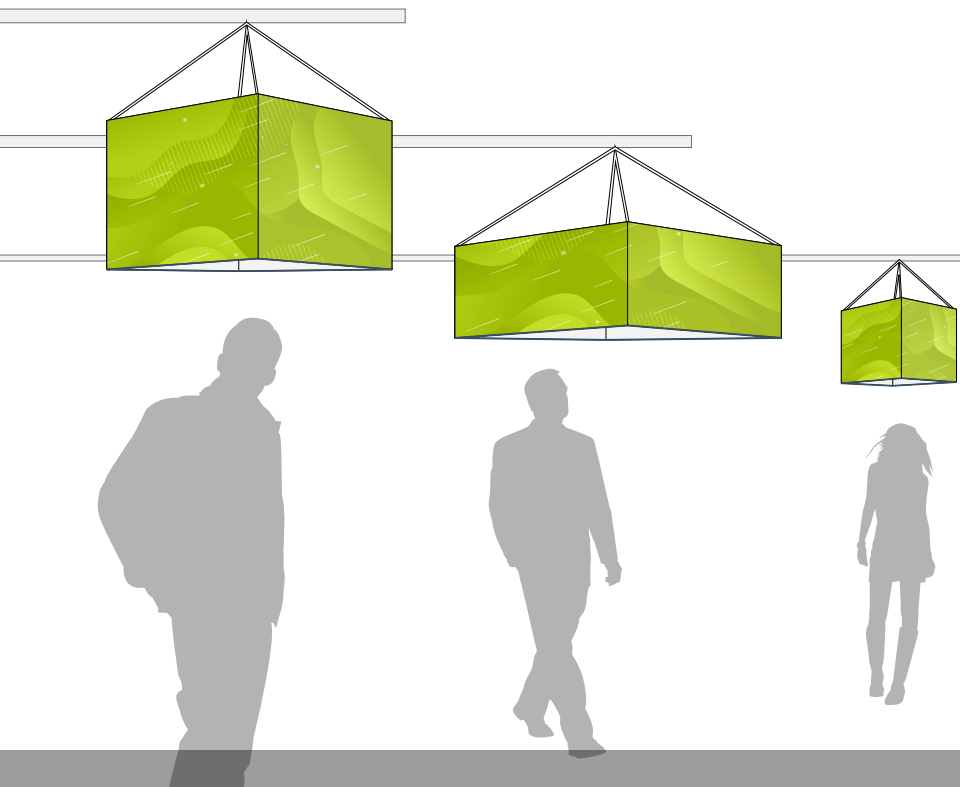

### LES AVANTAGES

- + Attire le regard de loin
- + Visuel interchangeable
- + Qualité photo
- + Visibilité 360°



Sac de transport



Ignifugé B1



Sans outils



Chaîne galvanisée pour une solidité à toute épreuve



Structure en tubes aluminium de 25mm de diamètre



Tubes de 1.5mm d'épaisseur



Sac de rangement pour faciliter le transport



Polyester maille bloquée 200 g/m<sup>2</sup> avec impression par sublimation

### Forme Rectangulaire

Structure emboîtable  
Tailles en cm

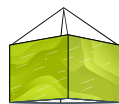

	S	M	L	XL
DIAMÈTRE	147x147	220x220	284x284	410x410
HAUTEUR	80 / 140	80 / 140	80 / 140	140 / 160

MONTAGE ET  
INSTALLATION  
3 MINUTES



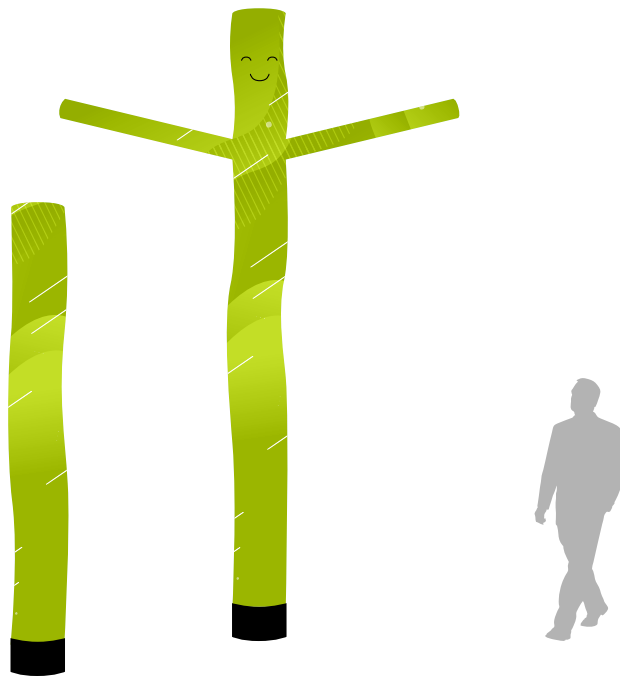

LES AVANTAGES

- + Jusqu'à 10m de hauteur
- + Plusieurs formes
- + Avec ou sans marquage
- + Soufflerie sur secteur



Sans outils



Taille sur mesure et plusieurs formes disponibles



Montage du visuel par velcro sur la soufflerie

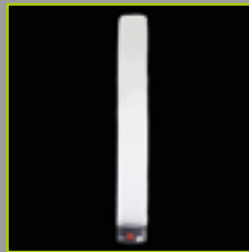

Existe en version lumineuse LED



Soufflerie permanente 950W



Nylon enduit PVC imperméable

MONTAGE EN 30 SECONDES

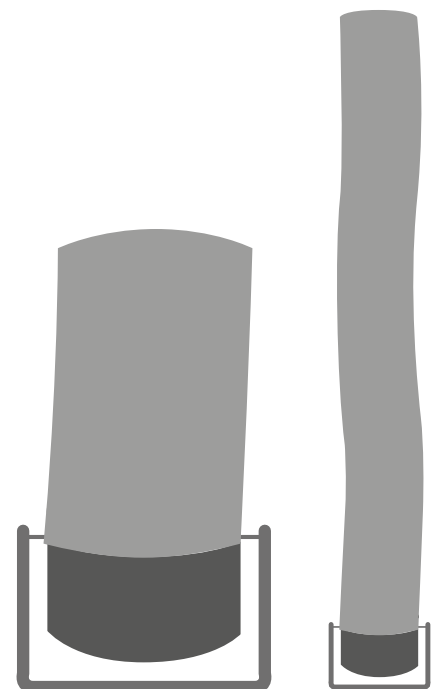



LES AVANTAGES

- + Se déplace facilement
- + Visuel changeable
- + Impression photo
- + Intérieur ou extérieur



Sans outils



Visuel recto-verso pour plus d'impact visuel

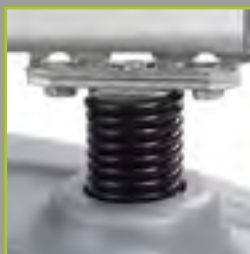

Montage sur ressorts pour la flexibilité au vent



Socle à remplir sur roulettes pour la mobilité



Poignet pour déplacer la structure facilement



Affiche A1 150g/m<sup>2</sup> avec impression HD



Tailles en cm

Structure Visuel

LARGEUR	67	59.4
HAUTEUR	102	84.1
POIDS KG	13.7	-

MONTAGE EN 3 MINUTES

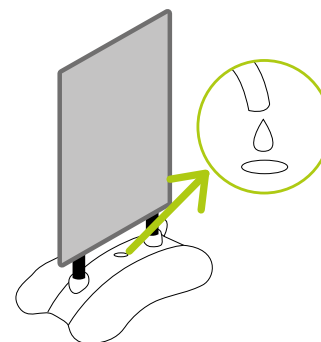
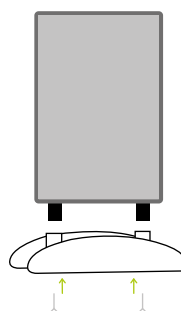
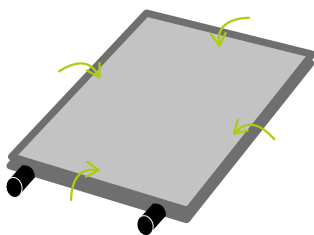
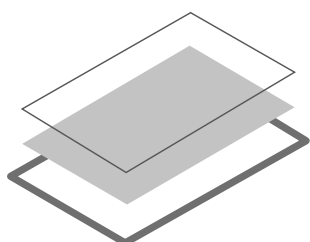



**ars**  
Agence Régionale de Santé  
Languedoc-Roussillon  
Midi-Pyrénées

ARS Languedoc-Roussillon-Midi-Pyrénées  
Direction générale  
Délégation départementale  
de l'Hérault







## Affichage mobile

- + X-banner
- + Roll-up
- + Walking banner
- + Totems Pop-Up
- + Barrières Pop-Up
- + Barrières sur cadre



LES AVANTAGES

- + Habille votre stand
- + Léger et pratique
- + Intérieur ou extérieur
- + Impression numérique
- + PVC ou Toile polyester



Sac de transport



Ultra léger



Sans outils

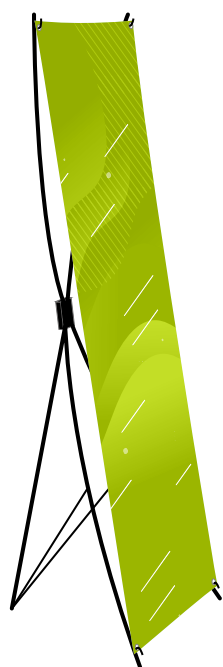

Structure monobloc déployable pour une utilisation rapide



Mâts d'accroche en fibre de verre souple

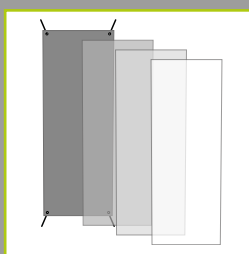

Visuel interchangeable



Sac de lest pour renforcer la structure en utilisation extérieure



Tissu polyester ou bache PVC



Tailles en cm

HAUTEUR

180

LARGEUR

70

MONTAGE EN 30 SEC

X BANNER

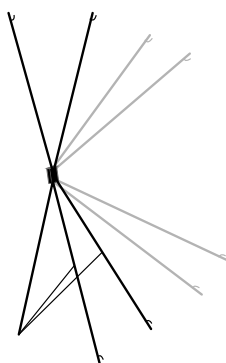

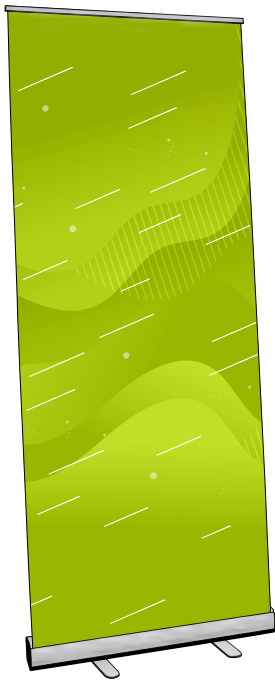

LES AVANTAGES

- + Informe et accueille
- + Tissu polyester ou PVC
- + Léger et pratique
- + Qualité photo



Sac de transport



Ultra léger



Sans outils



Sac de transport matelassé



Mât emboîtable, relié par un élastique



Structure en aluminium résistante

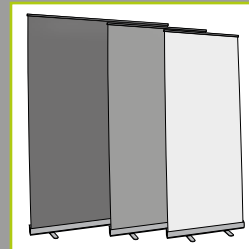

3 tailles disponibles pour tous les besoins



Support PVC 450g avec impression HD



Structures

Tailles en cm

M

L

XL

VISUEL

85x200

100x200

150x200

MONTAGE EN 30 SEC

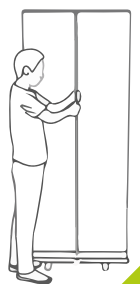
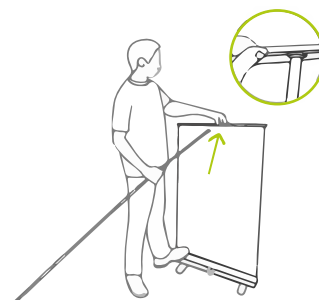
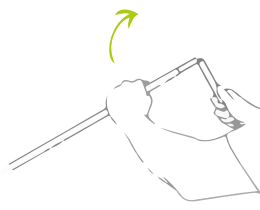
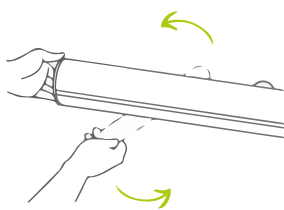

ROLL UP

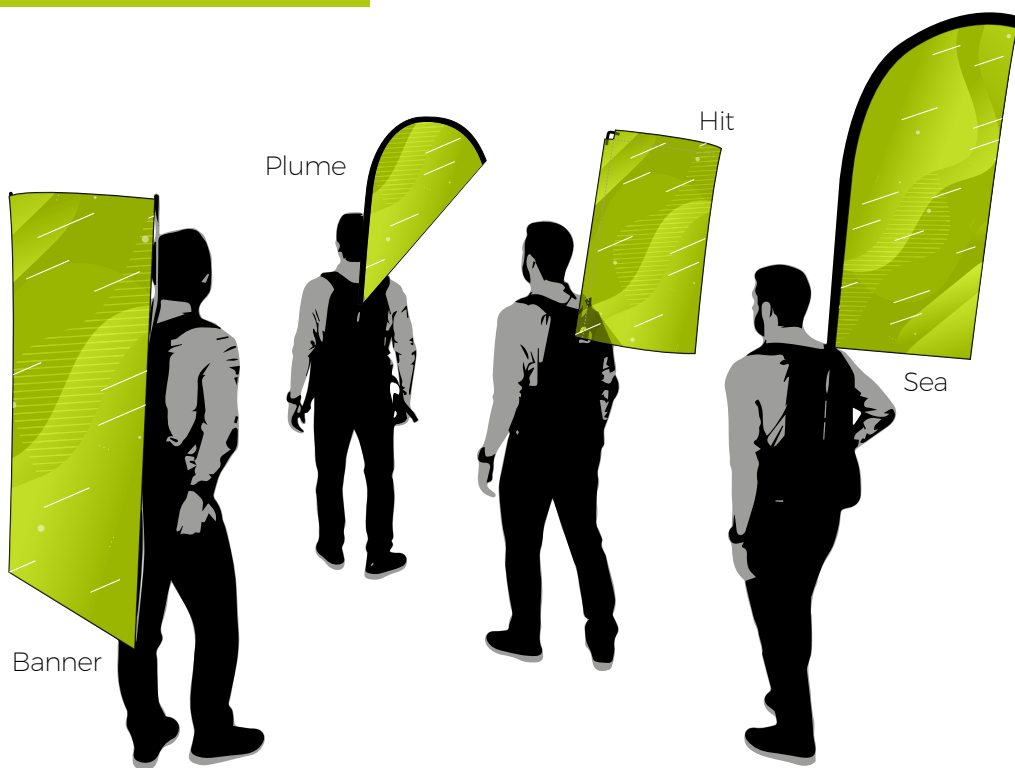

### LES AVANTAGES

- + Attire le regard
- + Idéal pour une utilisation itinérante
- + Léger et pratique
- + Qualité photo



Sac de transport



Ultra léger



Sans outils



Bretelles renforcées, ceinture réglable et poches sur les côtés



Compartiment de stockage zippé pour vos brochures et vos visuels



Système de fixation des mâts renforcé



Rangement pour les mâts et tiges

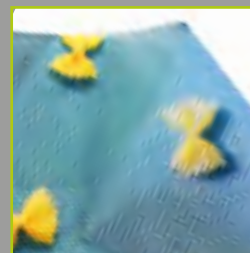

Polyester maille bloquée 115 g/m<sup>2</sup> avec impression par sublimation

WALKING BANNER

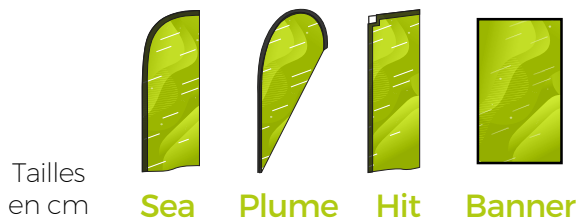

Tailles en cm

	Sea	Plume	Hit	Banner
MÂT	93	93	48x93	65x128
VOILE	50x127	50x98	50x87	50x120



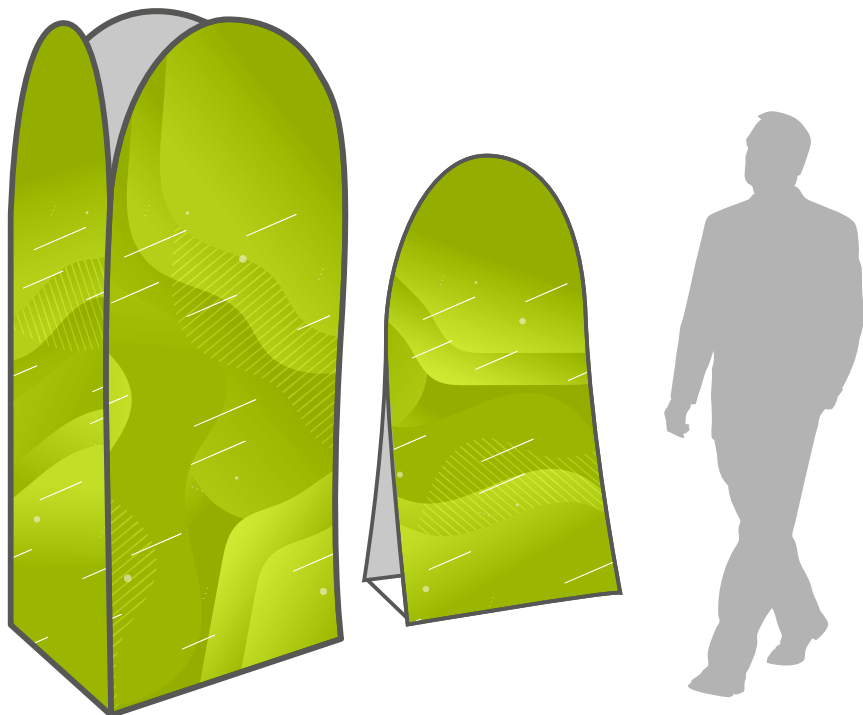

LES AVANTAGES

- + Montage simple et rapide
- + Informe et habille l'espace
- + Qualité photo
- + Nomade et léger



Sac de transport



Ultra léger



Sans outils



Montage des barres de renfort par velcro



Impression recto / verso pour une meilleure visibilité

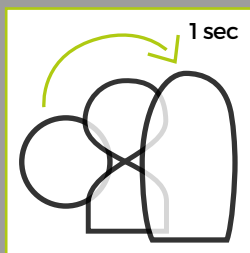

S'auto-déploie pour une installation instantanée



Sac de rangement pour le transporter facilement



Tissu polyester 200 g/m<sup>2</sup> avec impression par sublimation



Forme Vertical

Tailles en cm

S L XL

LARGEUR	100	100	100
HAUTEUR	150	200	300



Forme Tower

Tailles en cm

L

LARGEUR	100
HAUTEUR	200

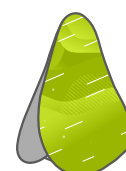

Forme Triangular

Tailles en cm

L

LARGEUR	150
HAUTEUR	160

MONTAGE ET DÉMONTAGE EN 5 SECONDES

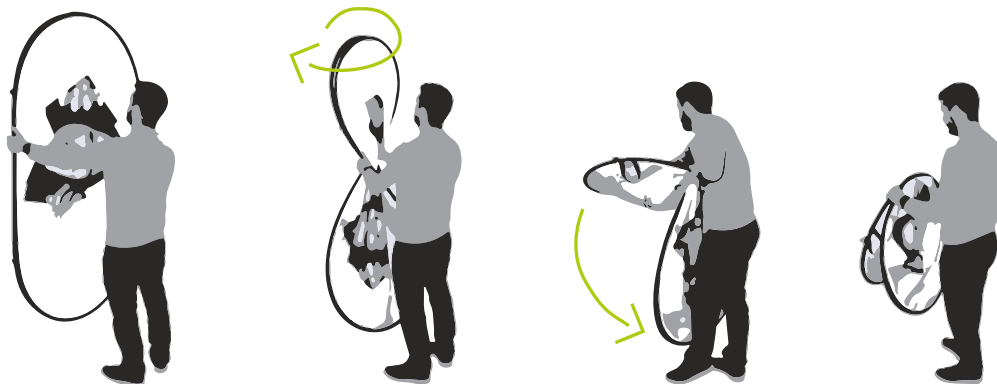

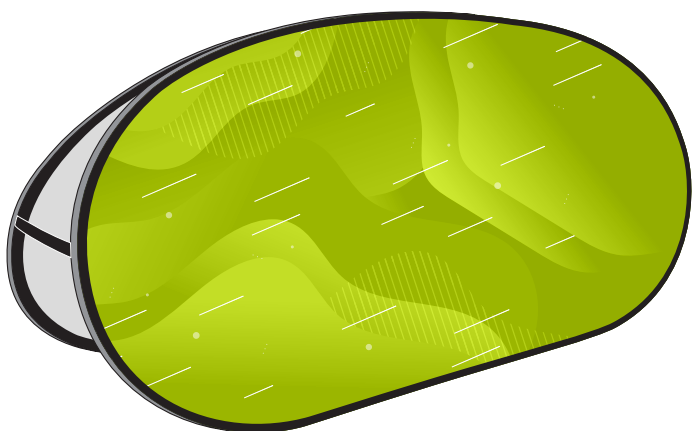

### LES AVANTAGES

- + Montage simple et rapide
- + Balise et habille l'espace
- + Qualité photo
- + Nomade et léger



Sac de transport



Ultra léger



Sans outils



Impression double face pour une meilleure visibilité

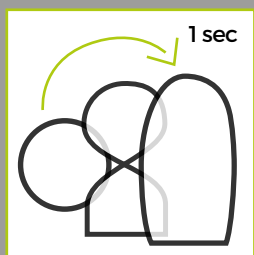

S'auto-déplie pour une installation instantanée



Sac de rangement pour le transporter facilement



Tissu polyester 200 g/m<sup>2</sup> avec impression par sublimation



Assemblage des barres de renfort par velcro



### Forme Ovale

Tailles en cm

	S	M	L	XL
LARGEUR	120	200	250	273
HAUTEUR	70	100	100	136



### Forme Rectangulaire

Tailles en cm

	S	M	L	XL	Square	Full
LARGEUR	150	200	250	300	140	200
HAUTEUR	75	100	100	100	140	140



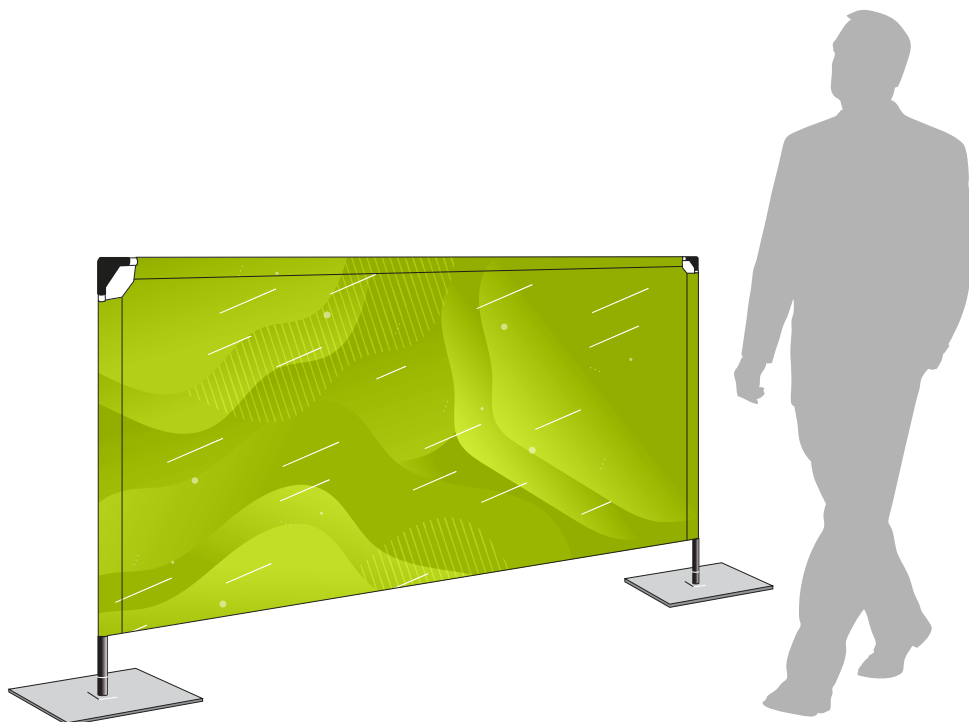

### LES AVANTAGES

- + Montage simple et rapide
- + Balise/délimite l'espace
- + Qualité photo



Montage en 3 mn



Résiste au vent



Sans outils



Platine simple ou double afin d'agrandir la zone de balisage



Fixation avec 2 piquets à frapper pour une utilisation sur sol meuble



Connexion droite ou d'angle pour moduler votre espace

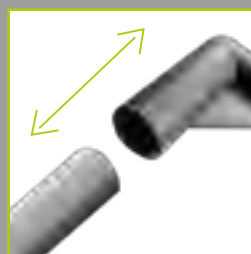

Segments emboîtables verrouillés par des clips



Polyester 115 g/m<sup>2</sup> ou bâche PVC 500 g/m<sup>2</sup> impression qualité HD



Tailles en cm

1m    2m    3m

STRUCTURE	100x100	200x100	300x100
VISUEL	100x90	200x90	300x90

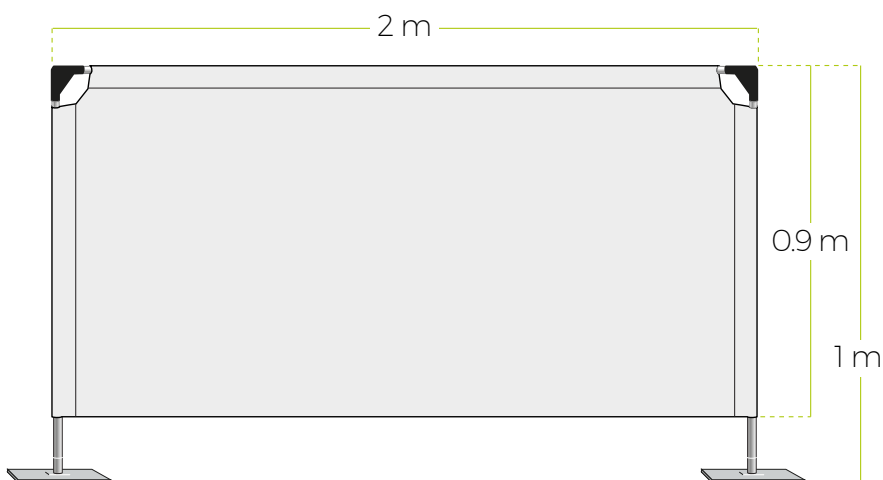

BARRIÈRES SUR CADRE







## Mobilier et aménagement

- + Mange debout
- + Table
- + Comptoir Pop-Up
- + Flex cube
- + Parasol
- + Transat

### LES AVANTAGES

- + Transport et stockage facile
- + Installation en 3 secondes
- + Plusieurs tailles et formes
- + Nappes et housses personnalisables
- + A compléter avec les chaises pliables

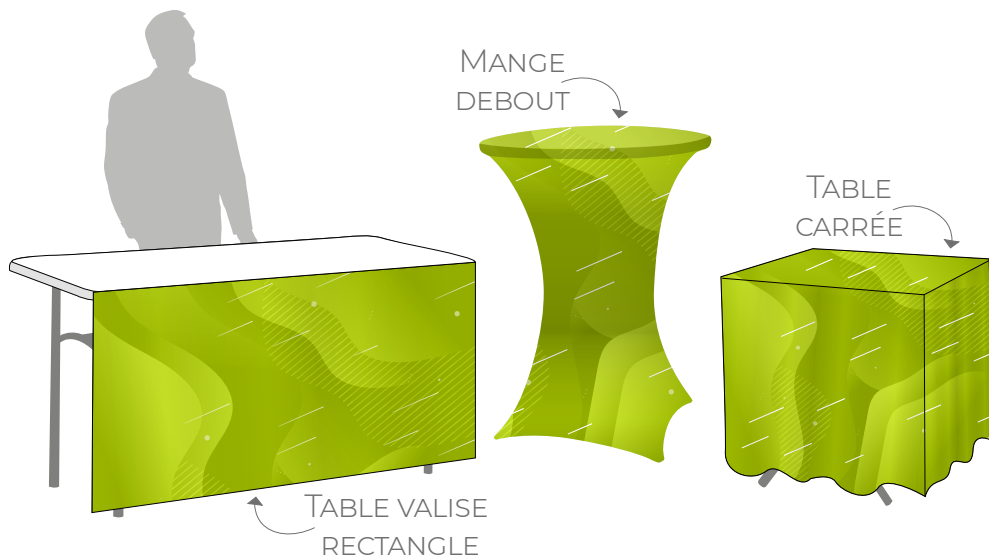

Structure en tubes métalliques

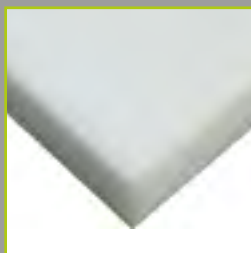

Plateau résistant en polyéthylène haute densité



Se déplie et se replie en 3 secondes



Bâche PVC à fixer par velcro pour le modèle valise rectangle



Housse en lycra imprimée pour les mange debout

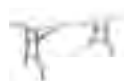

Tailles en cm

**Valise rectangle**

**Valise ronde**

**Table carrée**

**Mange debout**

**Comptoir ajustable**

DÉPLIÉE

183x76

Ø152

87x87

Ø81

75x50

HAUTEUR

77

77

77

108

57/64/74

PLIÉE

93x76x9

152x77x9

87x87x9

108x81x9

75x50 x9

POIDS EN KG

14

18

9.8

8

4.5

### POUR COMPLÉTER

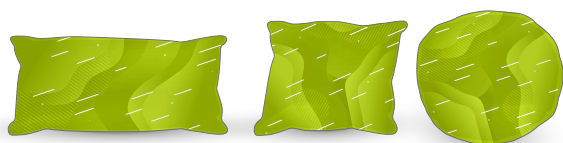

Coussins



Rideaux



### LES AVANTAGES

- + Finalise le stand
- + Point d'accueil client
- + Nomade et pratique
- + Etagère de rangement
- + Qualité photo



Sac de transport



Monobloc léger



Sans outils



9 kg tout compris pour équiper tous vos évènements



Structure aluminium verrouillée par des connecteurs



Etagère discrète pour garder un plan de travail toujours rangé



Visuel interchangeable en polyester imprimé fixé par velcro



Sac de rangement pour le transporter partout facilement

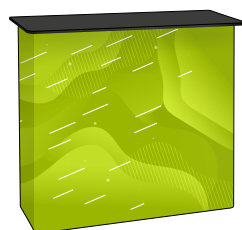

### Comptoir

Tailles en cm

HAUTEUR	99
LARGEUR	101
PROFONDEUR	32.5

### MONTAGE EN 2 MN

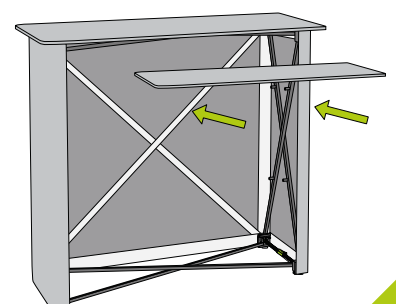
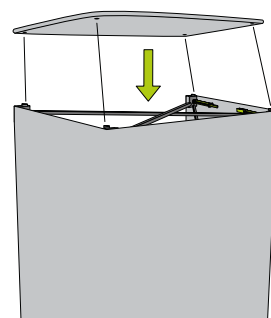
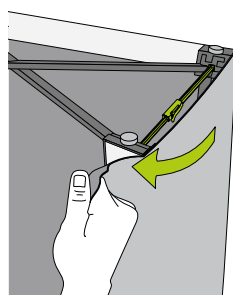
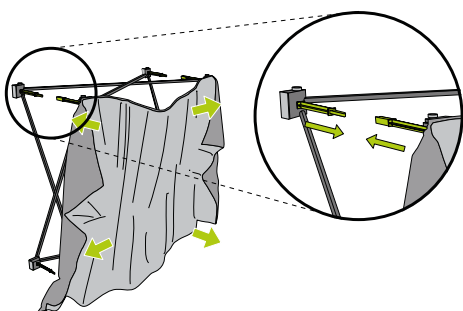

COMPTOIR POP-UP

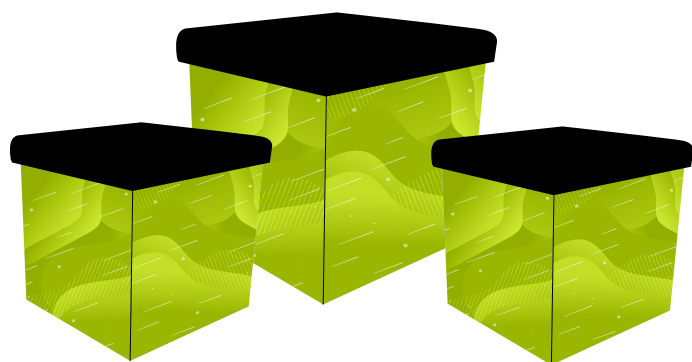

LES AVANTAGES

- + Habille votre stand
- + Encombrement minimum
- + Visuel interchangeable
- + Coffre de rangement
- + Impression sublimation



Sans outils

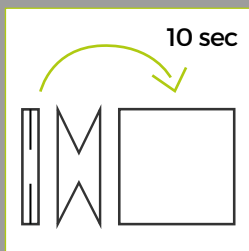

Rapide et facile à déplier



Construction en plaque de carton compressé de 3 mm d'épaisseur



Siège recouvert de revêtement en mousse pour plus de confort

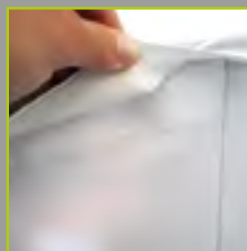

Visuel interchangeable facilement grâce aux velcros



Tissu Polyester 220 g/m<sup>2</sup> avec impression par sublimation



Tailles en cm

**M**    **L**

HAUTEUR    40    50

LARGEUR    40    50

MONTAGE EN 10 SEC

FLEX CUBE

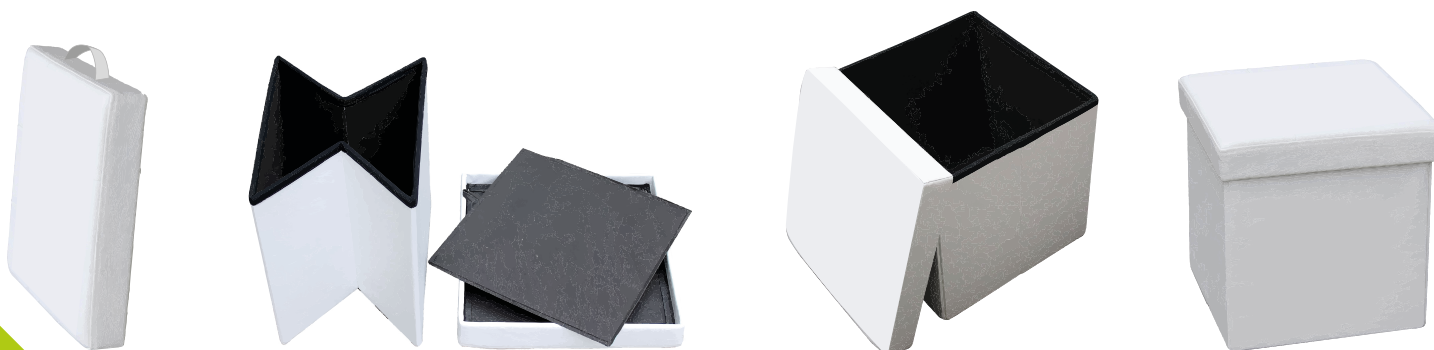



LES AVANTAGES

- + Polyester 220g/m<sup>2</sup>
- + Intérieur ou extérieur
- + Léger et pratique
- + Qualité photo

Tailles en cm	S	L
DIAMÈTRE	180	200
HAUTEUR	200	200

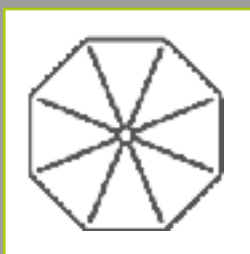

Toit composé de 8 pans imprimables



Structure acier blanc inclinable



Pied parasol à remplir 10 L



Piquet à planter sur sol tendre



Polyester 220 g/m<sup>2</sup> impression par sublimation

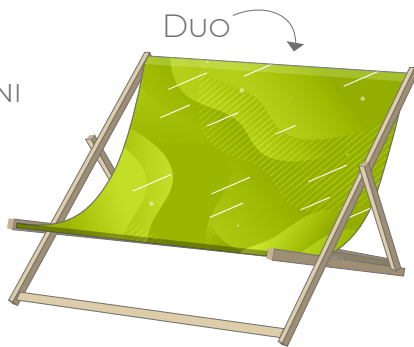
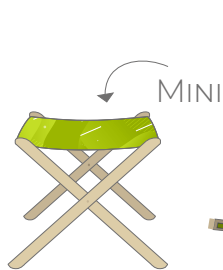

LES AVANTAGES

- + Crée une ambiance décontractée
- + Habille votre stand
- + Intérieur ou extérieur
- + Léger et pratique
- + Existe en version Duo XL



Structure en bois

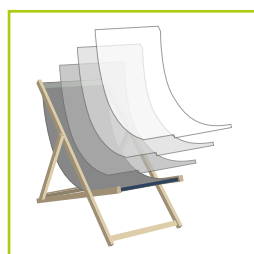

Visuel interchangeable



Polyester pelliculé PVC 300g/m<sup>2</sup> avec impression

Tailles en cm	Mini	One	Duo
HAUTEUR	37.5	120	120
LARGEUR	51	54	125

## TABLE DES MATIÈRES

PACK RESIST'O•.....	4
PACK STABIL'O•.....	6
PACK PRIM'O•.....	7
BEACHFLAG À LA CARTE•.....	8
ACCESSOIRES POUR BEACHFLAG•.....	9
PACK SUBLIM'O•.....	12
PACK NOMAD'O•.....	14
PACK PRIM'O•.....	16
PACK INDUST'O•.....	17
TENTES PLIANTES À LA CARTE•.....	19
TENTE XROOF•.....	22
ARCHE STABIL'O•.....	24
TOTEM•.....	26
BOUÉE•.....	27
STREET KAKEMONO•.....	30
PAVILLON SUR MESURE•.....	31
BANDEROLE & BÂCHES PVC•.....	34
IMPRESSION TISSU•.....	35
PANNEAUTIQUE ET ENSEIGNES•.....	36
ADHÉSIFS & AFFICHAGE PAPIER•.....	37
MUR D'IMAGE POP-UP•.....	40
MUR TUBULAIRE•.....	41
PHOTOCALL•.....	42
CADRE LUMINEUX•.....	43
CADRE ALUMINIUM•.....	44
ENSEIGNE ALUMINIUM•.....	45
TABLE FLAG•.....	48
DRAPEAUX PROMOTIONNELS•.....	49
SUSPENSIONS POP-UP•.....	50
SUSPENSIONS TUBULAIRES•.....	51
SKY DANCER•.....	52
STOP TROTTOIR•.....	53
X BANNER•.....	56
ROLL UP•.....	57
WALKING BANNER•.....	58
TOTEMS POP-UP•.....	59
BARRIÈRES POP-UP•.....	60
BARRIÈRES SUR CADRE•.....	61
TABLE & MANGE DEBOUT•.....	64
COMPTOIR POP-UP•.....	65
FLEX CUBE•.....	66
PARASOL & TRANSAT•.....	67



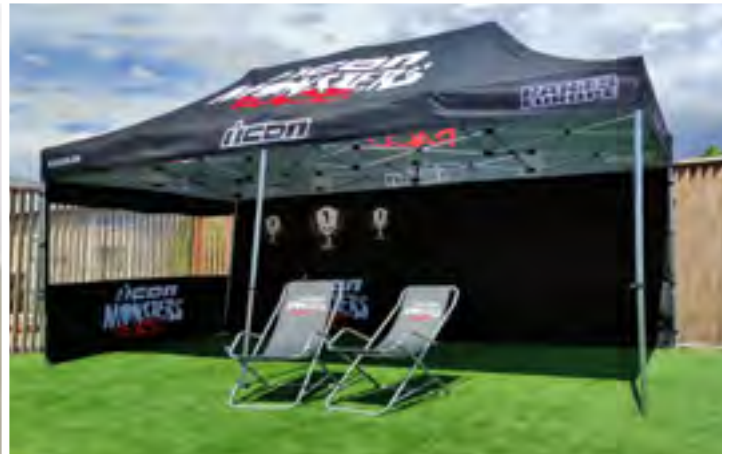

Simplifiez-vous la vie !